

Keywords

Thermodynamic Potentials,
Electrostatic Potential,
Chemical Potential,
Electron Gas,
Crystal Lattice

Received: September 15, 2015

Revised: October 15, 2015

Accepted: October 17, 2015

Mechanical and Thermal Electrization Metal, Dielectrics and Plasma

F. F. Mende

B. Verkin Institute for Low Temperature Physics and Engineering NAS Ukraine, Kharkov, Ukraine

Email address

mende_fedor@mail.ru

Citation

F. F. Mende. Mechanical and Thermal Electrization Metal, Dielectrics and Plasma. *International Journal of Modern Physics and Application*. Vol. 2, No. 6, 2015, pp. 73-99.

Abstract

Exists a large quantity of diagnostic methods of the study of the properties of materials and models. But from the view of researchers thus far slipped off the very promising method, based on a study of the electrostatic potential of such models. This method consists in the fact that with the heating, the deformation or the destruction of metallic and dielectric models around them the electric fields appear. In the work an experimental study of this method is carried out and its theoretical substantiation is given. According to the program "Starfish" July 9 1962 USA exploded in space above Pacific Ocean H-bomb. Explosion was accompanied by the appearance of electric pulse with the large the tension of electric field and by short duration. In the work the experiments on detection and study of the electric pulse, which appears with the warming-up of plasma inside Faraday's cell are carried out with the discharges through the dischargers of the capacitors of great capacity. It is shown that also with such discharges appears the pulse of electric field, which indicate appearance in the heated plasma of unitary charge. This fact contradicts not only the classical, but also relativistic conversions of electromagnetic field upon transfer from one inertial reference system to another and can attest to the fact that the absolute value of electric charge, in contrast to its polarity, is not the invariant of speed.

1. Introduction

Exists a large quantity of diagnostic methods of the study of the properties of materials and models. But from the view of researchers thus far slipped off the very promising method, based on a study of the electrostatic potential of such models. This method consists in the fact that with heating or deformation of metallic models on them the electric potential appears [1-3].

The majorities of the existing diagnostic methods of the control of properties and characteristics of materials and models is based on the application of various external actions, which can change the properties of such objects. The special interest present the methods of the nondestructive testing, and also those methods, whose application does not require action on models themselves. The special interest the remote methods of such of studies present. A study of the properties of materials and models into the dependence on their temperature, the pressures, the actions of different kind of irradiations, mechanical stresses and the dynamics of these processes, the kinetics of phase transitions are of great interest. In this paragraph the method, based on the measurement of the electrostatic potential of models, which gives the possibility to conduct such studies by simple method, is examined.

In the literary sources, in which is discussed a question about the possible dependence of charge on the speed, it is asserted that the dependence of magnitude of the charge from this parameter would lead with heating of conductors to an increase in their negative potential.

If in any structure coexists several thermodynamic subsystems, then their chemical potential must be equal. In the conductor there are two subsystems: lattice and electron gas, electron gas in the conductors at usual temperatures is degenerate and is subordinated the statistician Fermi-Dirac, his chemical potential is determined from the relationship

$$\mu = W_F \left(1 - \frac{\pi^2 (kT)^2}{12W_F^2} \right), \quad (1.1)$$

where

$$W_F = \frac{h^2}{2m} \left(\frac{3n}{8\pi} \right)^{\frac{2}{3}}, \quad (1.2)$$

is Fermi energy, h is Planck's constant, and n , m are electron density and their mass.

From relationships (1.1) and (1.2) is evident that chemical potential of electron gas with a temperature decrease increases, reaching its maximum value at a zero temperature. It also depends on electron density.

In general form chemical potential for any subsystem can be found from the following expressions

$$\mu = \left(\frac{\partial U}{\partial N} \right)_{S,V} = \left(\frac{\partial F}{\partial N} \right)_{T,V} = \left(\frac{\partial W}{\partial N} \right)_{S,P} = \left(\frac{\partial \Phi}{\partial N} \right)_{T,P}$$

where N is number of particles, and the thermodynamic potentials U, F, W, Φ represent internal energy, free energy, enthalpy and Gibbs potential respectively. But, if we find chemical potential of lattice, using one of these expressions, then it will be evident that with a temperature decrease this potential decreases. Thus, it turns out that chemical potential of electrons with a temperature decrease grows, and it decreases in lattice. But as then to attain so that they would be equal? Output consists in the fact that chemical potential of electron gas depends on the density of free electrons, and so that this potential with the decrease of temperature also would decrease, must with a temperature decrease decrease a quantity of electrons. This means that for retaining the electroneutrality during cooling of conductor from it the draining of electrons must be provide ford, and with the heating their inflow is provide ford. If we this do not make, then with the heating at the model will appear positive potential, but during the cooling negative.

For the experimental confirmation of this behavior of conductors one should connect to the sample under investigation electrometer with the very high internal resistance and begin model to cool. In this case the electrometer must register a change in the electric potential

of model. Especially strong dependence will be observed at low temperatures, when the heat capacity of electron gas and lattice of one order. However, what must occur upon transfer of model into the superconductive state? During the passage the part of the electrons will begin to be united into the Cooper pairs and in the region of Fermi energy will begin to be formed the energy gap of the forbidden states. Moreover, for the remained normal electrons this there will also be forbidden zone; therefore for them only places of higher than the upper edge of slot will remain permitted. This will lead to the fact that it will not be sufficient vacant places for the remained electrons, therefore, in the case of the absence of the draining of electrons from the model, it will acquire negative potential.

Chemical potential of lattice depends also on stresses and number of dislocations, and conduction electrons will also track this process.

2. Experimental Study of the Emergence of the Electric Potential on the Metal Samples and Insulators

Figure 1 is shown the temperature dependence of the electrostatic potential of model, made from niobium-titanium alloy, with a change in its temperature within the limits of 77-4.2 K [1-3].

It is evident that with the decrease of temperature the negative potential grows first sufficiently slowly, but in the temperature range of the passage of model into the superconductive state is observed a sharp drop in the potential.

A study of the influence of mechanical stresses and kinetics of dislocations on the electrostatic potential of models was conducted employing the following procedure. For this copper flask with the thickness of the walls ~ 3 mm. and by volume near ~ 5 liters of it was placed into vacuum chamber, from which could be pumped out air. The end walls of flask were executed in the form hemispheres. The internal cavity of flask in conducting the experiments was found under the atmospheric pressure. Pumping out or filling into vacuum chamber air, it was possible to mechanically load its walls. Flask itself was isolated from vacuum chamber bushing from teflon resin and thus it had high resistance relative to the housing of unit. One of the typical dependences, obtained with such experiments, is represented in Fig. 2 It is evident that the amplitude of effect reaches ~ 100 mV, dependence has strong hysteresis, moreover an increase in the negative potential corresponds to the tension of the walls of flask. In the figure the circuit on the hysteresis loop was accomplished clockwise. It follows from the obtained results that mechanical stresses of model lead to the appearance on it of electrostatic potential. The presence of hysteresis indicates that the formation of dislocations bears the irreversible nature. In this case the irreversibility of the

influence of dislocations on the electrization is connected with the fact that dislocation they can, falling into potential

wells, to be attached on the heterogeneities of crystal structure.

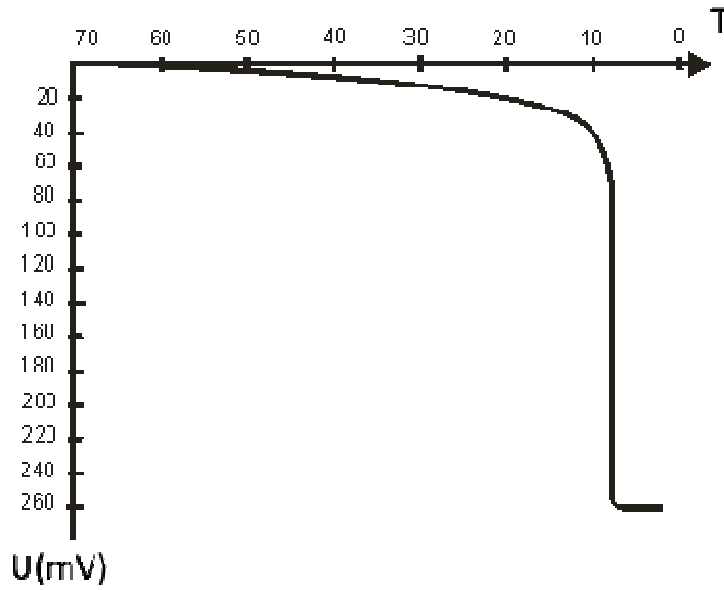

Fig. 1. Dependence of the potential of niobium-titanium model on the temperature.

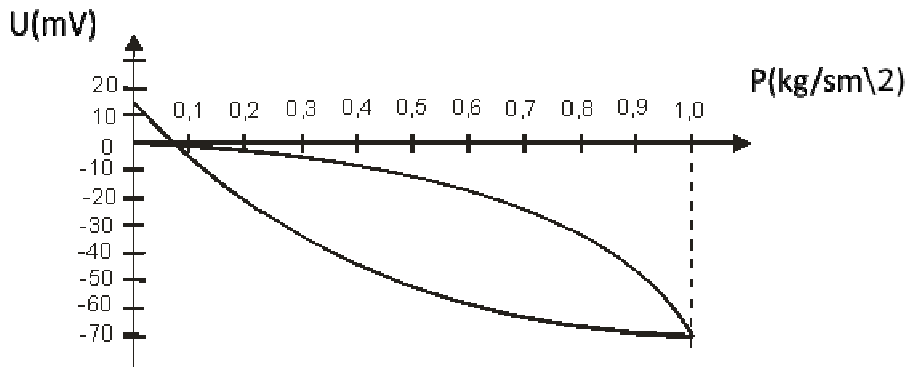

Fig. 2. Dependence of the potential of copper flask on the external pressure.

It follows from the carried out examination that also the appearance of rapid (impact) mechanical loads also must lead to the appearance in the isolated metallic model of pulse potential. This question was investigated on the installation, whose schematic was given in Fig. 3

Internal capacity is suspended to the external screen with the aid of wide neck. For eliminating the galvanic contact between the external screen and the internal capacity the neck has a section. Odd parts of the neck are connected by the insulating plates, which in the figure are designated by the short black sections of lines. Internal capacity is prepared from aluminum in the form of flask, its end walls are executed in the form hemispheres. This construction of end walls is necessary in order to avoid their severe strain with the realization of the explosions of explosive in the internal capacity. Common form installations for investigating the dynamic loads on the aluminum flask and the component parts of the installation are shown in Fig. 4 and Fig. 5.

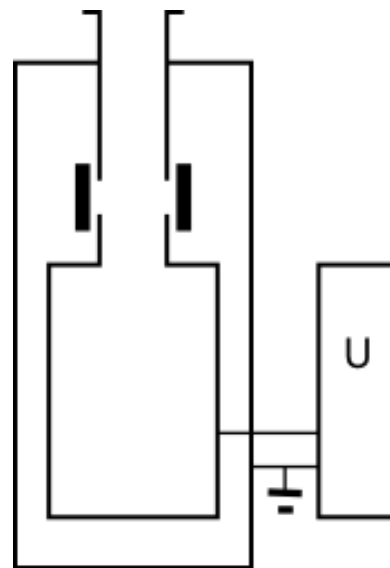

Fig. 3. Installation diagram for investigating the appearance of the pulses of electric field with the impact loads.



Fig. 4. General view of the installation for the study of dynamic loads.



Fig. 5. Position Type unassembled.

During the inclusion into neck from a height 1 m of the bottom of the internal capacity of the rod with a weight 200 g between the external screen and the internal capacity is observed the voltage pulse, shown in Fig. 6. In order to avoid to the appearance of additional pulses with a lateral drop in the rod after the impact of its end about the bottom of flask, the side of rod is wound by soft tissue. Data of this experiment correspond to the experimental data, obtained with the copper flask, the code its tension led to the appearance on the flask of negative potential. With the impact of the end of the rod about the bottom of flask also occurs the local deformation of its bottom, with which in the point of impact occurs the tension.

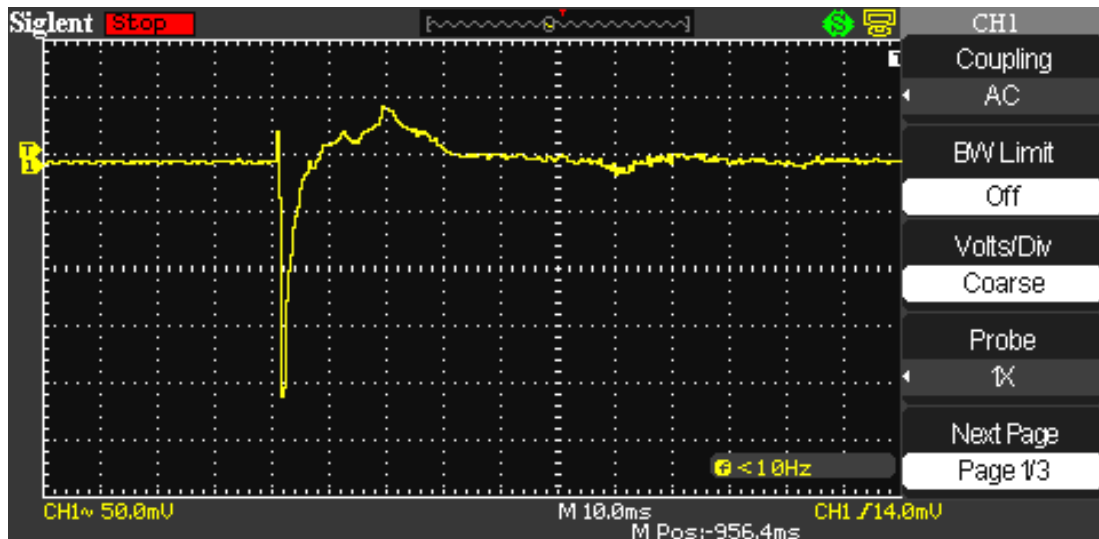

Fig. 6. Shape of pulse after a drop in the rod on the bottom of internal capacity.

If we inside the aluminum flask explode the charge of small value, then is observed the voltage pulse, shown in Fig. 7.

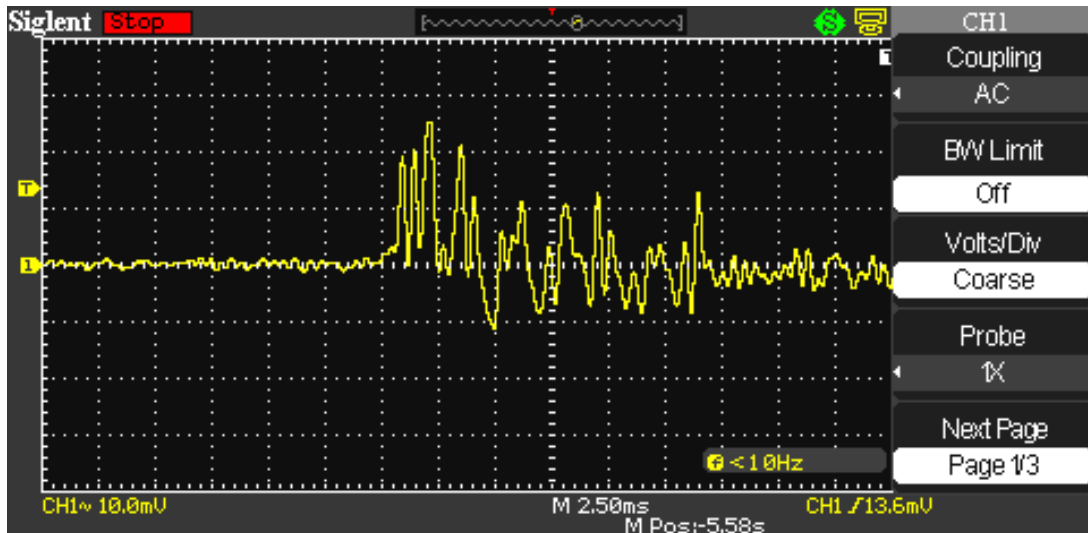

Fig. 7. Form of the voltage pulses, obtained with the explosion of explosive in the aluminum flask.

On the oscillogram seen repeated bipolar pulses resulting from multiple reflection of the shock wave from the walls of the flask, resulting in its deformation. And there are pulses corresponding to both stretch the walls of the flask, and their compression. If we into the aluminum flask place the spring,

isolated from the flask, and to force it periodically to be compressed, then potential on the flask also bears periodic nature. The experiment indicated was conducted according to the diagram, depicted in Fig. 8.

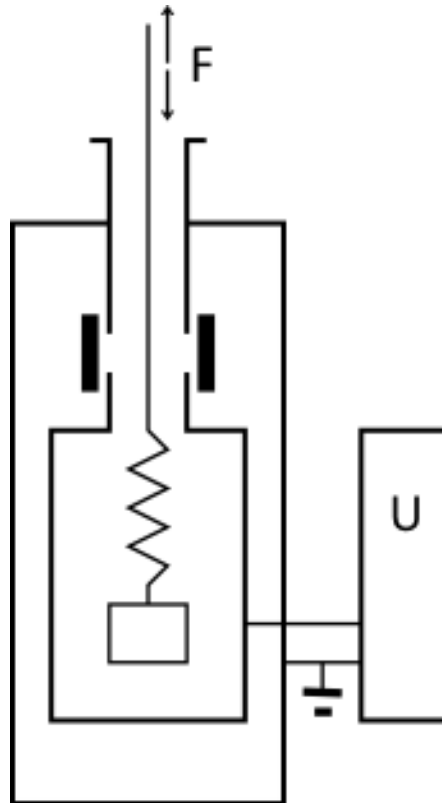

Fig. 8. Diagram of experiment with the spring.

To the cotton cord, the outgoing outside flask, is fastened the spring, from which is suspended the load. This system is had the mechanical resonance, whose resonance frequency, determined by spring constant and by cargo weight. If we toward the end cord exert periodic force at the frequency of

resonance, then it is possible to attain the periodic deformation of spring at this frequency with in effect constant position of load.

The dependence of electric potential on the flask, obtained in this experiment, it is shown in Fig. 9.

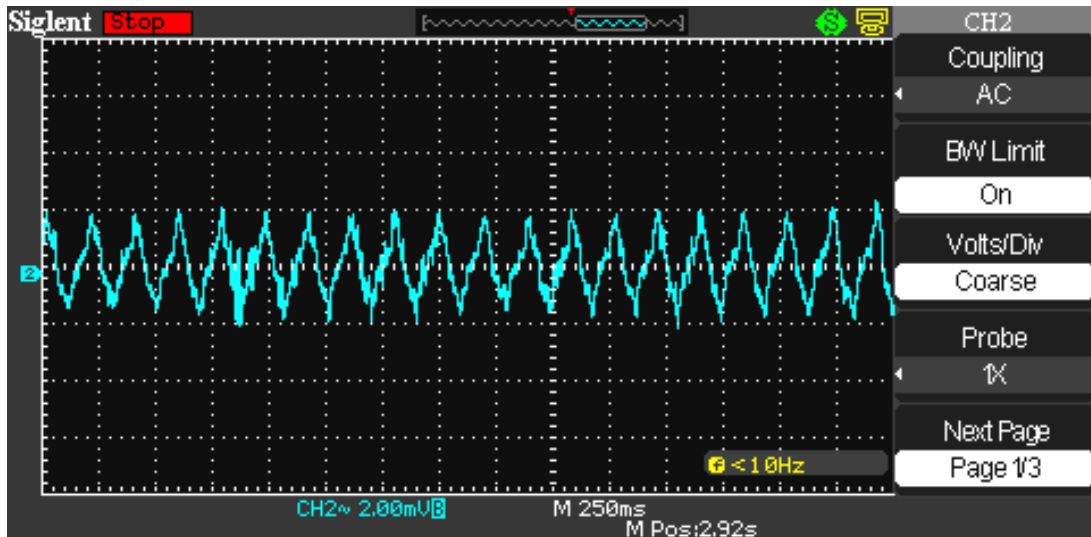

Fig. 9. An alternation in the potential on the flask with the periodic compression of spring.

Obtained data attest to the fact that in the process of the deformation of spring, in the flask the alternating unitary charge is formed.

If we inside the flask tear thin copper wire, then the

voltage pulse also is observed between the flask and the external screen. This experiment was conducted according to the diagram, shown in Fig. 10.

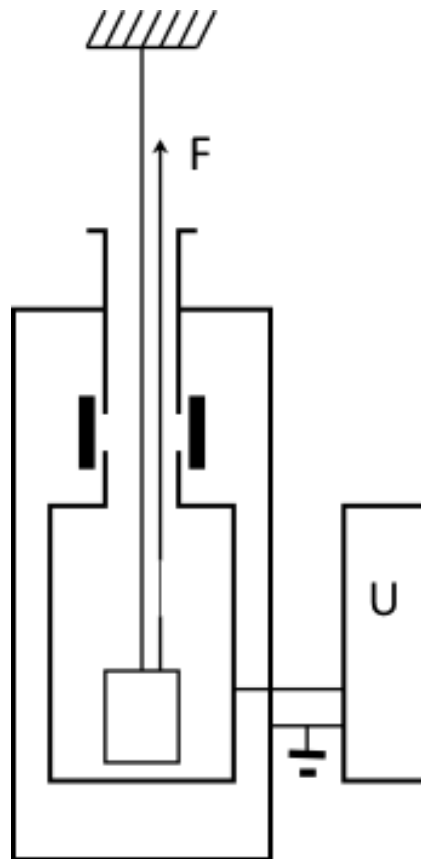

Fig. 10. Experiment on the break inside the flask of copper wire.

The load is suspended inside the flask from the cotton cord. In parallel with the thread, from which is suspended the load, is located another cotton cord, in break of which is fixed the

section of the copper wire with a diameter 0.3 mm. At the moment of the break of the wire between the flask and the external screen is observed the pulse, depicted in Fig. 11.

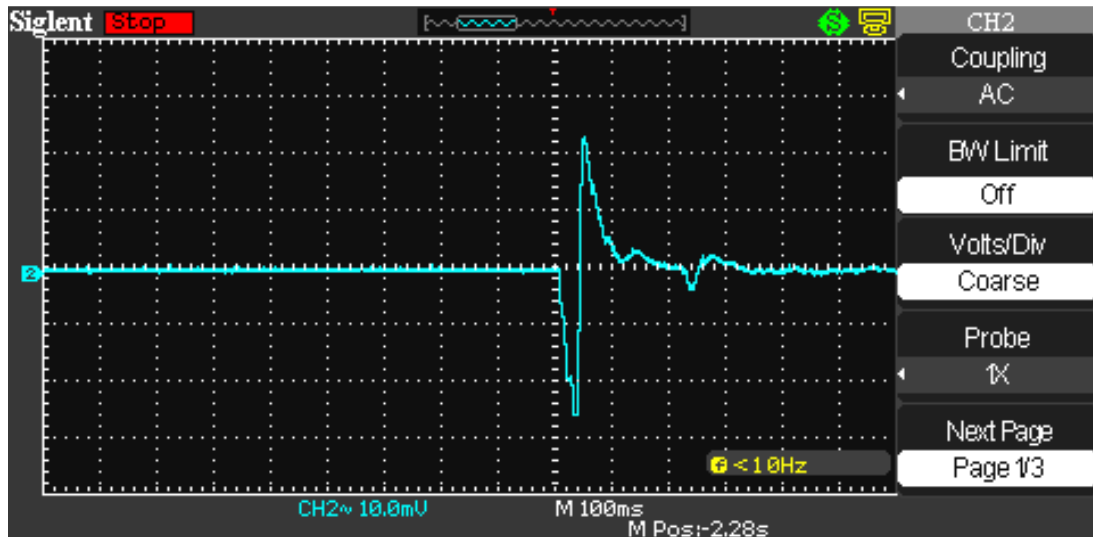

Fig. 11. Pulse, obtained with the break of wire.

The negative part of the pulse corresponds to the tension of wire, which precedes its break. The positive part of the pulse corresponds to relaxation of deformation stress two parts of the torn wire.

In such a manner both the mechanical deformation of wire and its break it is accompanied by the appearance of unitary charge inside the flask.

It is considered that by the way of external actions it is not possible to create electric field inside Faraday cage. However, this not thus. If we the metallic capacity, utilized as Faraday cage, strike by hammer, then the dipole antenna, located inside the cell, will fix the pulses of electric field. The experiment, which confirms this fact, was conducted according to the diagram, given in Fig. 12.

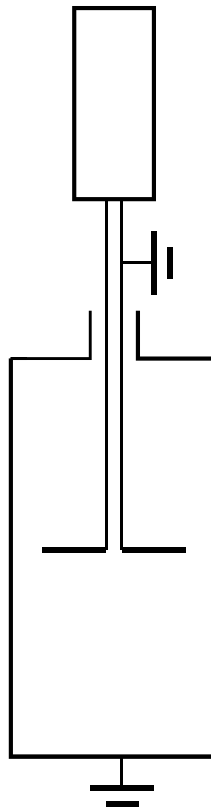

Fig. 12. Field on experiment on the detection of pulse electrical inside Faraday cage.

As Faraday cage was used the external screen of the installation, depicted in Fig. 4. Inside the screen was located the dipole antenna, to which was connected the oscilloscope.

If we strike by hammer the screen of Faraday cage, then oscilloscope fixes the voltage pulses, shown in Fig. 13.

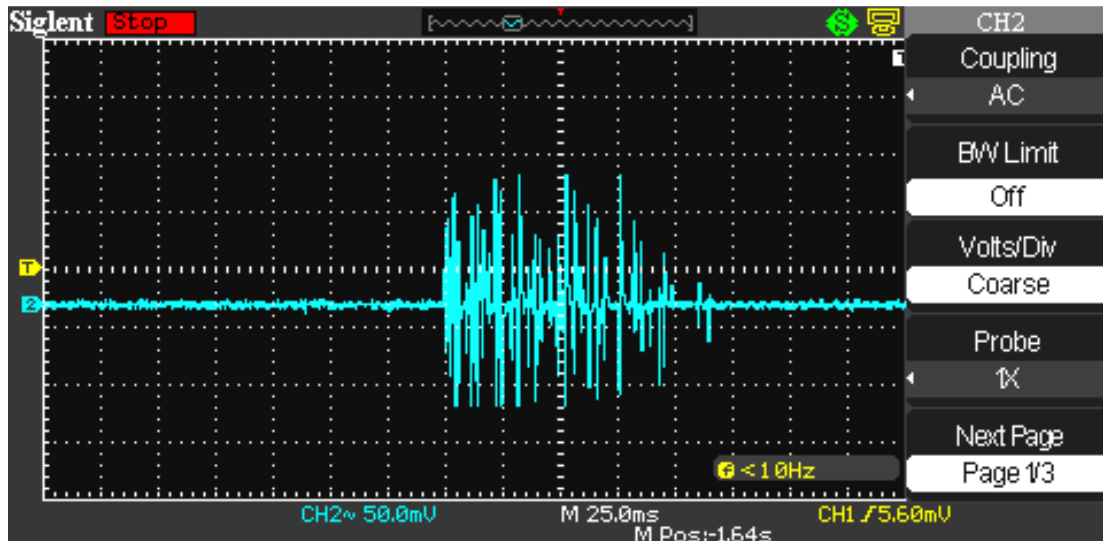

Fig. 13. Voltage pulses, fixed inside Faraday cage.

From the conducted investigations it is possible to make the important conclusion that mechanical deformations or destruction of metallic models is accompanied by the appearance of external electrical field on. This result has great physical value and can be used in the practice for creating the instrument for investigations of the mechanical

properties of models.

Electrization occurs and mechanical deformations dielectrics. If we conduct experiment with the dielectrics employing the procedure, depicted in Fig. 10, it is possible to obtain the following results. With the break of silk thread is observed the oscillogram, given in Fig. 14.

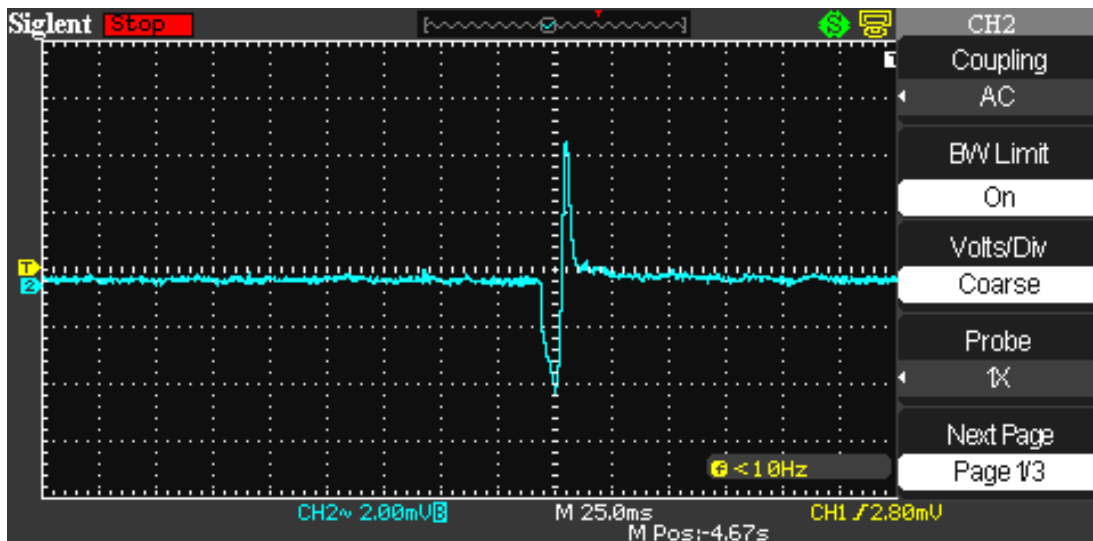

Fig. 14. With the break of silk.

In Fig. 15. is depicted the oscillogram, observed with the break of thread from vinyl chloride.

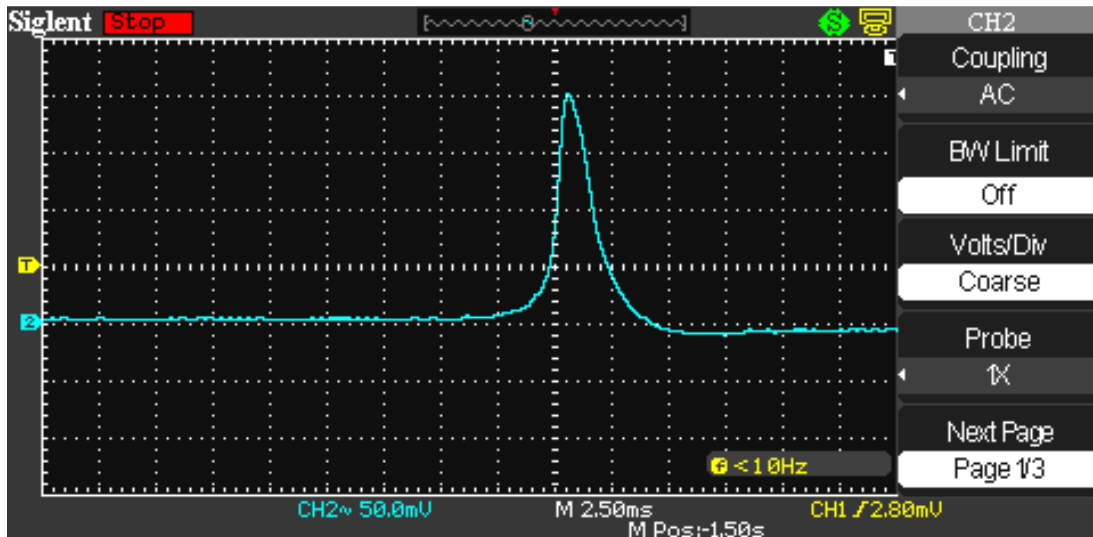

Fig. 15. Is depicted the oscillogram, observed with the break of thread from vinyl chloride.

If we as the thread use the lace, interlaced from the synthetic fibers, and to subject to its periodic mechanical loads, then will be obtained the oscillogram, given in Fig. 16.

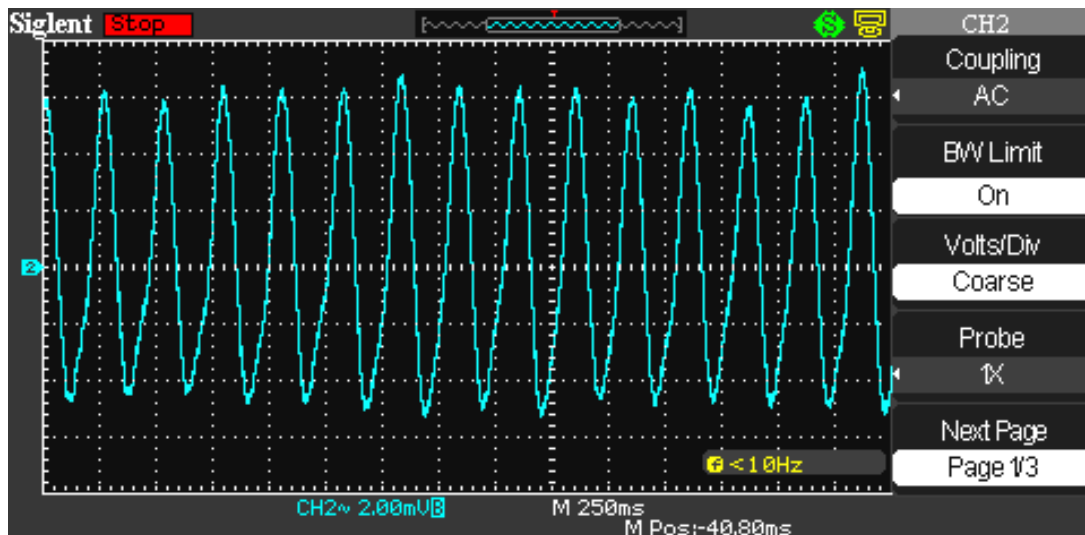

Fig. 16. Oscillogram, observed during application to the lace of periodic mechanical loads.

Such properties of dielectrics earlier in the scientific publications are not described, but they speak, that it is possible to obtain the unitary charge of different signs by the way of compression or tension of the dielectrics, placed in Faraday cage in it.

3. Electrization with the Warming-up of the Plasma

According to the program "Starfish" July 9, 1962 USA exploded in space above Pacific Ocean H-bomb. This event placed before the scientific community many questions [4,5].

It is earlier into 1957 Nobel laureate Hans Albrecht Bethe being based on the theory of dipole emission, predicted that with a similar explosion will be observed the electromagnetic pulse (EMP), the strength of field of which on the earth's surface will comprise not more than 100 V/m. But with the explosion of bomb discomfiture occurred, field on the tension of electrical, beginning from the epicentre of explosion, and further for the elongation of more than 1000 km of it reached several ten thousand volt per meters. Electric pulse had not only very large amplitude, but also very short duration on the order ~ 150 ns (Fig.17).

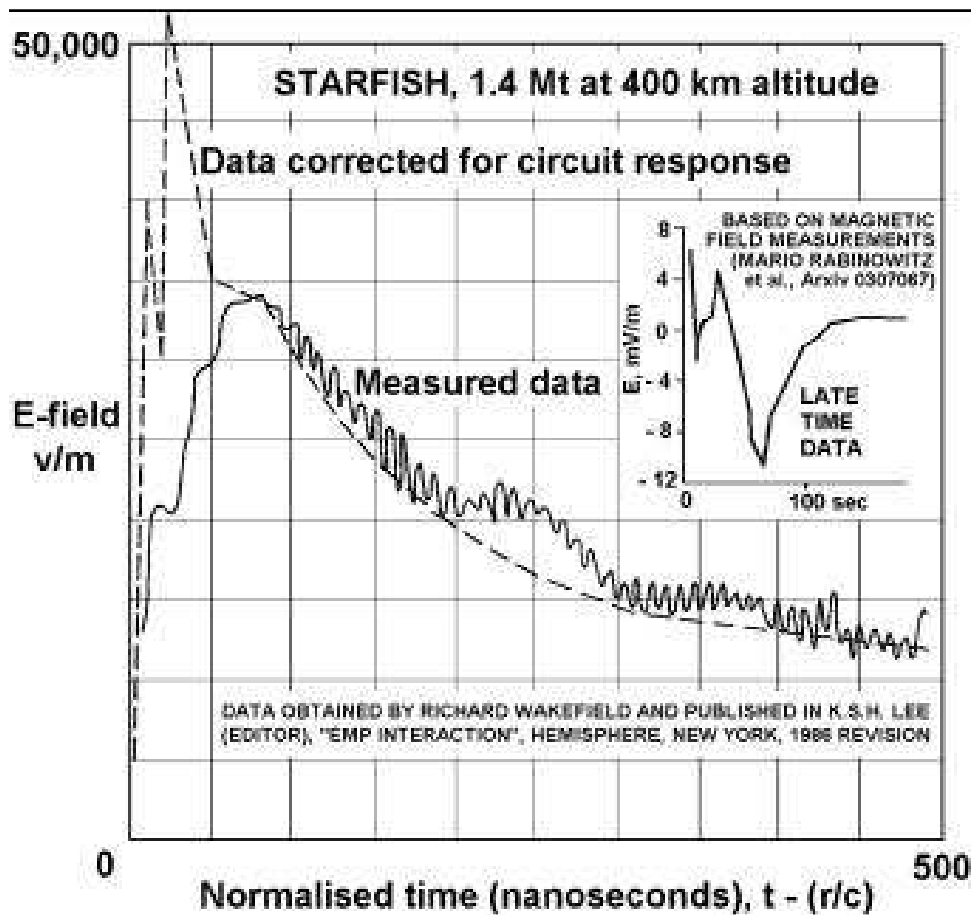

Fig. 17. Experimental dependence of amplitude EMI on the time, obtained with the tests according to the program "Starfish".

Thus, after explosion in the course of several ten minutes there is no radio communication with Japan and Australia, and even at a distance into 3200 km of from the epicentre of explosion were fixed ionospheric disturbances, which several times exceeded those, which are caused by the most powerful solar flares. Explosion influenced also the automatic spacecraft. Three satellites were immediately disabled. The charged particles, which were appeared as a result explosion, were seized by the magnetosphere of the Earth, as a result of which their concentration in the artificial Earth radiation belt it increased by 2-3 orders. The action of radiation belts led to the very rapid degradation of solar batteries and electronics in seven more satellites, including in the first commercial telecommunication satellite tele-Star. On the whole explosion derived from system third of the automatic spacecraft, which were being found in low orbits at the moment of explosion.

With the explosion of nuclear charge according to the program "Program K", which was realized into USSR, the radio communication and the radar installations were also blocked at a distance to 1000 km of. It was discovered, that the registration of the consequences of space nuclear explosion was possible at the large (to 10 thousand kilometers) distances from the point of impact. The electric fields of pulse led to the large pickup to the power cable in the lead shell, buried at the depth ~ 1 m, which connects power station in Akmol with Alma-Ata. The electric pickup were so great that the automation opened cable from the

power station.

Is known that the problem of this phenomenon attempted together with his students to solve and academician Zeldovich [6]. However, in the existing sources there is no information about the fact that this problem was solved by it. Exponential is the fact that more than fifty years in the official scientific journals there are no publications on the explanation of the phenomenon indicated, which attests to the fact that the scientists lacks the substantiated point of view on the explanation of the physical causes for this phenomenon.

The first article with the explanation this of phenomenon appeared in the periodical Engineering physics only in 2013 [7]. In the article the attempt to explain this phenomenon within the framework is made of the concept of scalar- vector potential, represented in the works [8-12]. This concept assumes the dependence of the scalar potential of charge on its relative speed. This dependence is obtained from the analysis of the laws of the induction of electric field by magnetic and the magnetic field electrical, recorded with the use by the substantial derivative of field functions in the form, invariant not relative to the group of Poincare, but relative to the transformations of coordinates of classical physics, which include the Galileo conversions. Subsequently the concept of scalar- vector potential and its practical results were published in a number of the foreign periodicals [13-22]. In these publications it is shown that the concept of scalar-

vector potential is the basis of all dynamic laws of electrodynamics, charges connected with the motion.

Up to now there are only indirect experimental data, which confirm the validity of the concept of scalar vector potential, which consisted in the observation of the electric pulse of nuclear explosions [4,10,7,19, 22], and also in the appearance of an electric potential on the superconductive windings and the tori during the introduction in them of the direct current [23-26]. Proposed article gives experimental results on the detection of the pulse of the external electric field, which appears with the warming-up of plasma. Is given also one of the possible explanations of this phenomenon within the framework of the concept of scalar- vector potential.

4. Experimental Observation of the Electric Field Pulse on Heating The Plasma

In the experiments for the warming-up of plasma the micro-bursts with the discharge of the chemical capacitors of the great capacity through the discharger or with the discharge of such capacitors through the lamp of photoflash were used. In the discharger was used the copper wire, with the connection to which the charged capacitors it was melted and evaporated, being converted into the plasma. The diagram of experiment is shown in Fig. 18 and Fig. 19. In Faraday cage, which serves the continuous metal screen (on the figures it is depicted as dotted line) are placed the chemical capacitors of great capacity, the discharger and the key, which makes it possible to connect to the discharger the charged capacitors. The chains of outline, which include capacitor, key and discharger did not have galvanic contact with the screen of Faraday cage. Faraday cage surrounds one (Fig. 18) or two (Fig. 19) metallic of screen. Characteristic measurement of electric pulse it was achieved with the aid of the digital memory oscilloscope SIGLENT SDS 1072CNL. In the first case (Fig. 18) oscilloscope was connected between the screen of the cell of Faraday and the external screen.

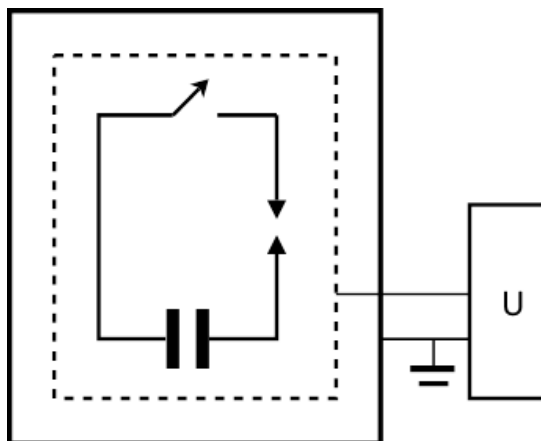

Fig. 18. Diagram of experiment with one external screen.

In the second case (Fig. 19) the oscilloscope was connected between the external screen and the intermediate screen, located between the screen of the cell of Faraday and the external screen.

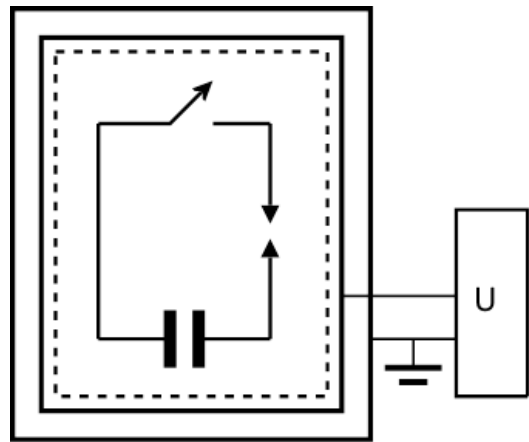

Fig. 19. Diagram of experiment with the intermediate screen.

The schematic of experimental installation is shown in Fig. 20.

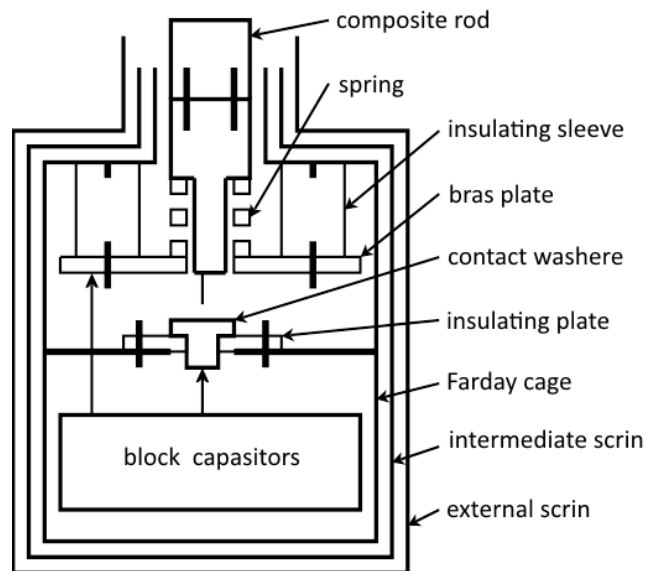

Fig. 20. The schematic of experimental installation.

The composite stock, which forms part of installation, consists of two parts. Its upper part is made from ebonite, the lower part, made from brass, is fastened to it with the aid of the fastening pin. Between the lower part of the stock and the brass plate there is a spring, which ensures the electrical contact between the brass part of the stock and the brass plate. Inside the screen of Faraday cage is a partition, to which is attached the insulating plate. Contact washer is located on this plate. The unit of capacitors is connected between the brass plate and the contact washer. To the lower part of the stock are attached thin copper wire, gauge 0.2 mm, its length, which comes out from the stock is 5 mm. During lowering of stock the wire concerns contact washer, and the charged

capacitors are connected to it: wire is melted and evaporates, being converted into the plasma. In the installation they were used the collection of the chemical capacitors with a total capacity $6000 \mu F$, which were charged up to voltage 300 v.

Fastening bolts and pins are shown in the figure by the fatty sections of lines. The joints, which make it possible to connect the oscilloscope between the screen of the Faraday cage and the external screen, and also between the external and intermediate screen, are not shown. Are not shown also the joints, through which is achieved the charge of capacitor. With the measurements the cable, through which is achieved the charge of capacitor, from Faraday cage is disconnected.

The photograph of the screen of Faraday cage it is shown in Fig. 21.



Fig. 21. The photograph of the Faraday cage.

Diameter of the upper and lower part of the screen of the cell of Faraday 180 mm and 220 mm respectively. Height of the upper part 80 mm, and lower is 220 mm. The upper part of the screen is capped, to which is attached the tube, into which is put composite stock. Length of tube 100 mm. The screen of Faraday cage is covered with three layers of acrylic auto-enamel. This layer presents the insulator, above which stuck the aluminum foil, which presents intermediate screen.

In Fig. 22 the separate parts of installation are depicted.



Fig. 22. Photograph is installation in the dismantled form.

The lower part of the photograph presents external screen. Its diameter 300 mm, and a height 600 mm. On top on the external screen, closed with cover, stands Faraday cage. In the installation in the assembled form Faraday cage is located inside the external screen on the insulating table.

In the process of experiments it was established that the surge voltage appears with the capacitor discharge through the discharger between the screen of the Faraday cage and the external screen.

In order to be certified in the fact that with the warming-up of plasma in Faraday cage actually is formed the unitary charge, was carried out the following experiment. It is known that with the rubbing by the fur of amber on it is formed the negative charge. After rubbing by the fur of model from the amber it with the aid of the stock, prepared from the ebonite, through the tube in the upper lid of camera was introduced into Faraday cage, and then rapidly was pulled out from it. When oscilloscope was connected between the screen of the cell of Faraday and the external screen, was registered the pulse, whose oscillogram was shown in Fig. 23.

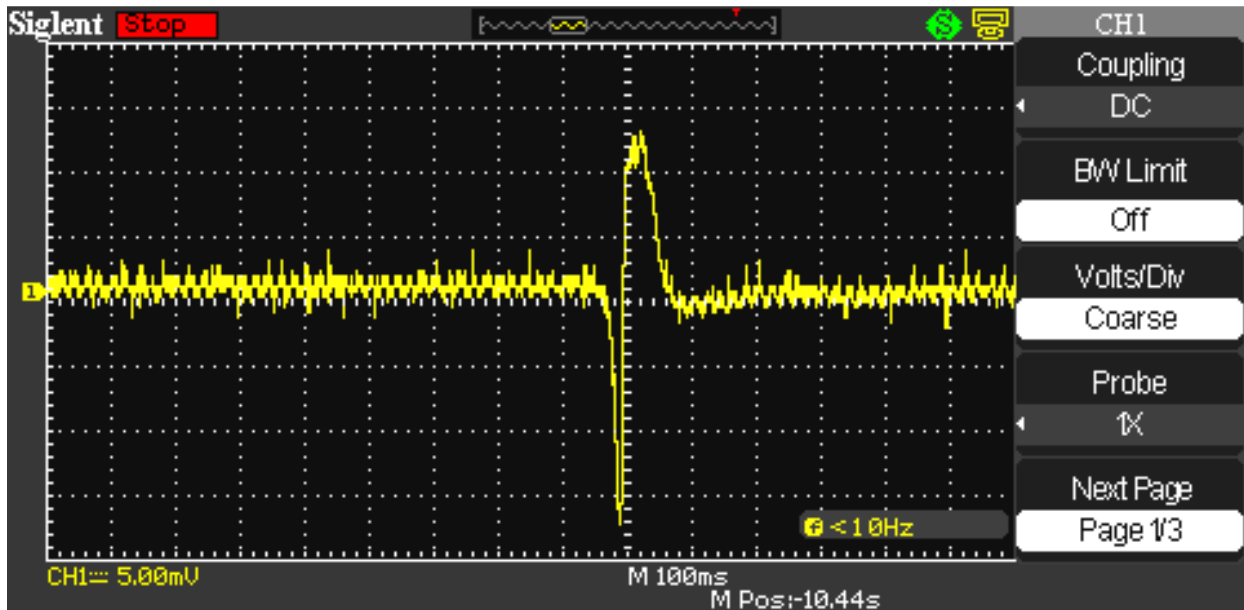

Fig. 23. Shape of pulse with the rapid withdrawal of the model of the charged amber from Faraday cage.

If we model from the amber slowly introduce into the cell, to and then rapidly withdraw it from there, then is observed the pulse, shown in Fig. 24.

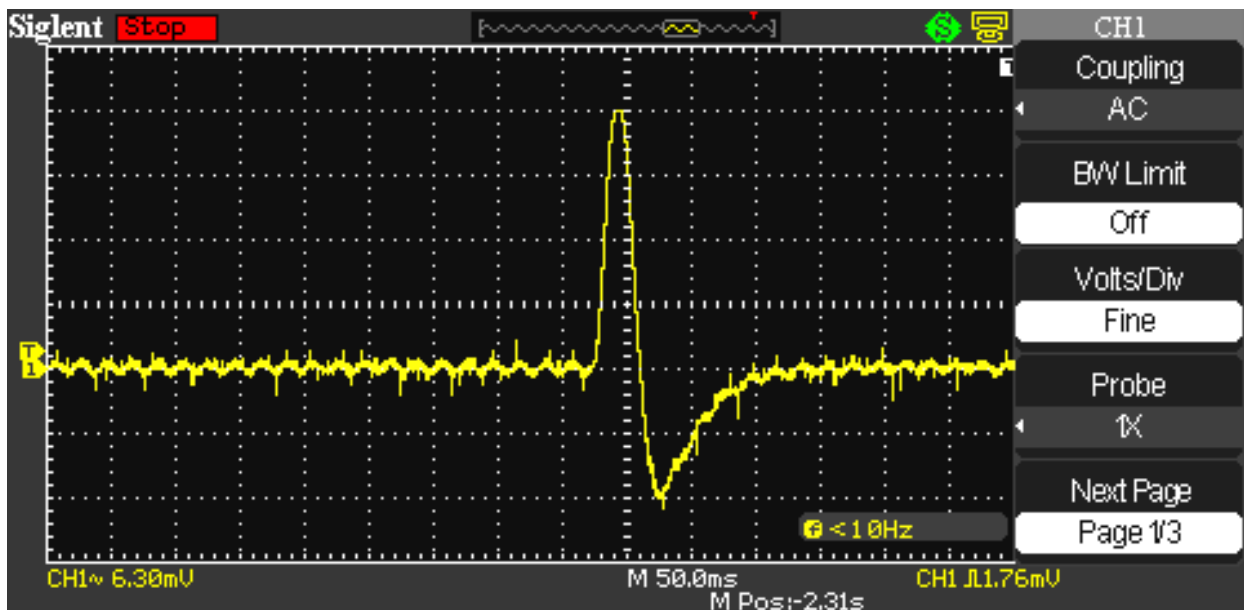

Fig. 24. Shape of pulse with the rapid withdrawal of the model of the charged amber from Faraday cage.

If we the charged model from the amber rapidly introduce into the cell and to immediately just as rapidly tzyat it from there, then is observed pulse shown in Fig. 25

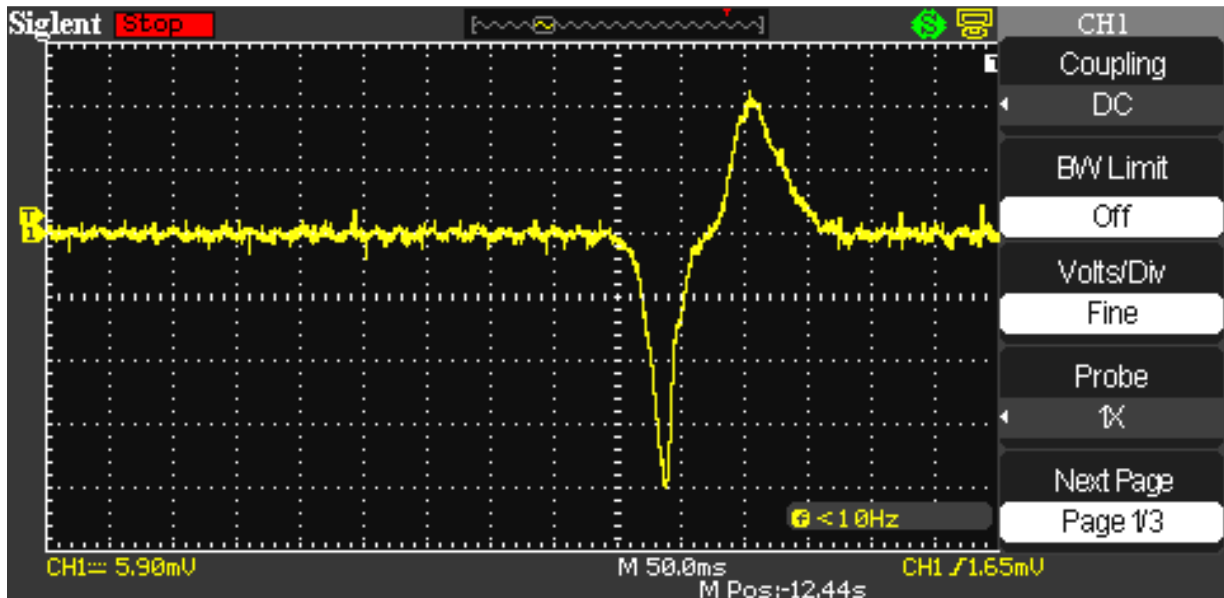

Fig. 25. Voltage pulse, obtained with the rapid introduction and the subsequent withdrawal from the cell of Faraday of the charged model of amber.

The process examined can be considered as appearance and subsequent disappearance in the cell of Faraday of negative charge. It is evident that between the negative and positive part of the pulse is a region, where the derivative of the pulse amplitude on the time decreases. This is connected with the fact that with the mechanical introduction and the withdrawal of the model of amber from Faraday cage it is not possible to instantly change the speed of stock for the reverse. In the following stage of studies it was explained, in what

time the charged capacitors are discharged through the discharger, and also was written the signal, proportional to current, current in the discharge circuit. Total capacitance of capacitors was $6000 \mu F$, they were charged to voltage 300 V. The oscillograms of transient process with the capacitor discharge through the discharger with different scanning speeds along the axis X, and also signal of proportional to current in the circuit discharge, they are shown in Fig. 26 and Fig. 27.

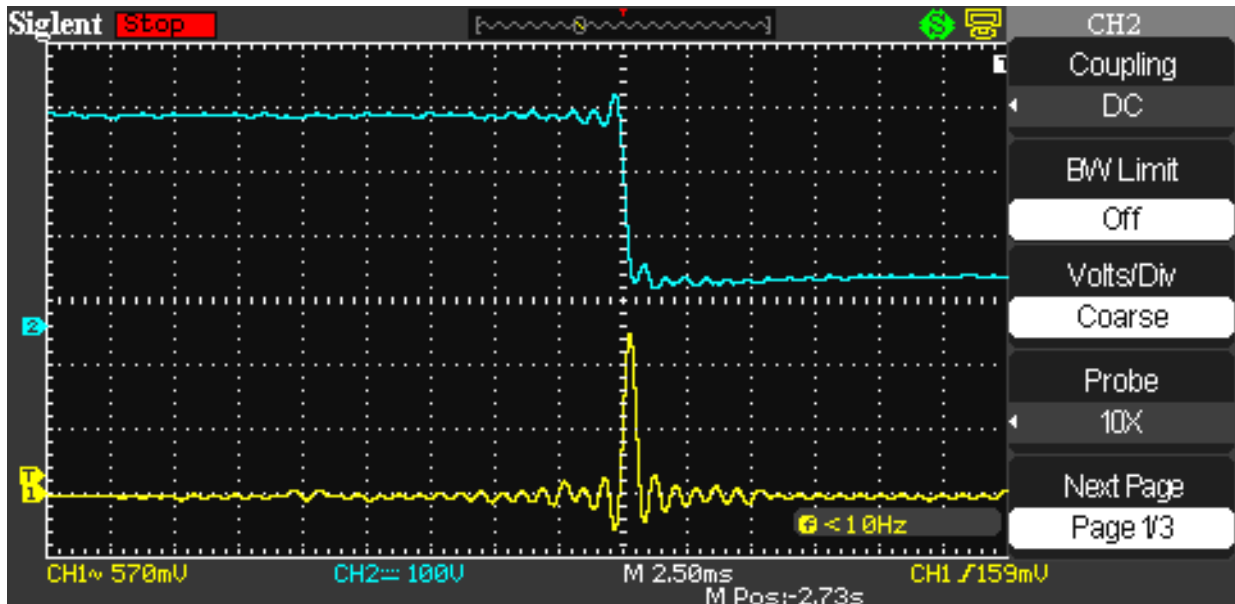

Fig. 26. The oscillogram of transient process with the capacitor discharge through the discharger is represented. Scale value along the axis X is 2.5 ms.

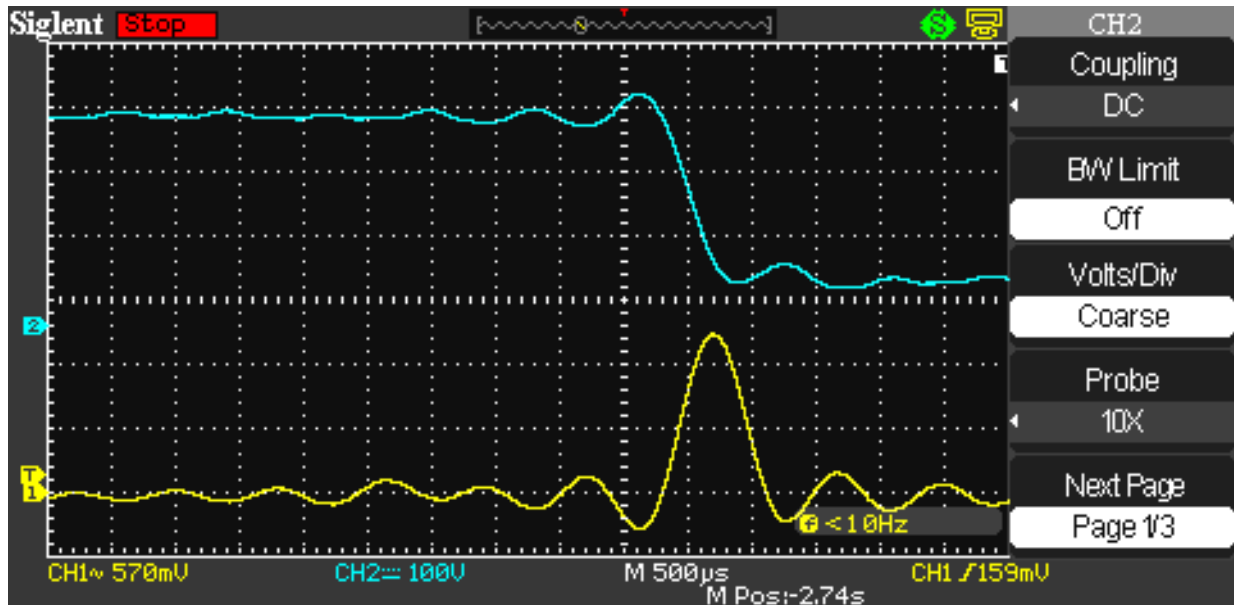

Fig. 27. The oscillogram of transient process with the capacitor discharge through the discharger is represented. Scale value along the axis X is 2.5 ms.

The measurement of a voltage drop across capacitors during their the discharge through the discharger, and also the signal, proportional to the current of discharge, was made according to the diagram of that represented in Fig. 28.

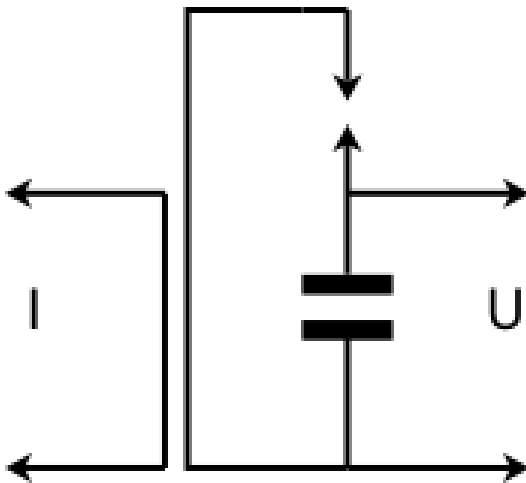

Fig. 28. The measurement of a voltage drop across capacitors during their the discharge through the discharger, and also the signal, proportional to the current of discharge.

The chain, with the aid of which was measured the signal,

proportional to the current of discharge, was inductively connected with the conductors of outline. The conductor, fixed in parallel to one of the conductors of outline, was used for this.

The dependence on the time of voltage across capacitors during the discharge is represented in the upper oscillogram. It is evident that in the time ~ 500 s the voltage falls from 300 V to 50 V. Lower oscillogram presents the current pulse, registered by the method examined.

The difference between the energy of the capacitors, charged to 300 V in those charged to 50 V composes 263 J, therefore the average power of micro-burst is ~ 530 kW. If one considers that for the heating, the melting and evaporating the wire of discharger it is necessary to spend energy ~ 10 J, then the remained energy ~ 250 George goes to the warming-up of the formed plasma.

It is evident from the given oscillograms that the current, which flows through the plasma reaches its maximum value toward the end of capacitor discharge.

The form of the voltage pulse between the external screen and the screen of Faraday cage, obtained with the discharge through the discharger of the capacitors with a capacity $6000 \mu\text{F}$, charged to the voltage 300 v, it is shown in Fig. 29.

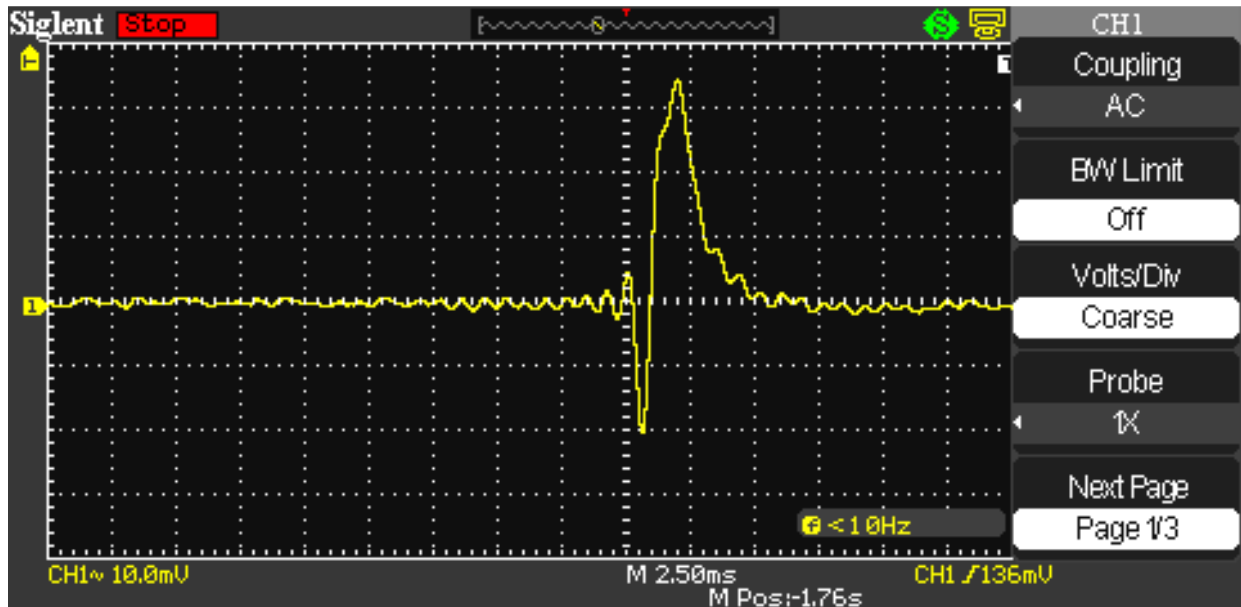

Fig. 29. Form of the voltage pulse between the external screen and the screen of Faraday cage, obtained with capacitor discharge with a capacity $6000 \mu\text{F}$, charged to the voltage 300 V . Scale along the X-axis is 5 ms .

The same pulse with the scale value the axis X $500 \mu\text{s}$ is shown in Fig. 30.

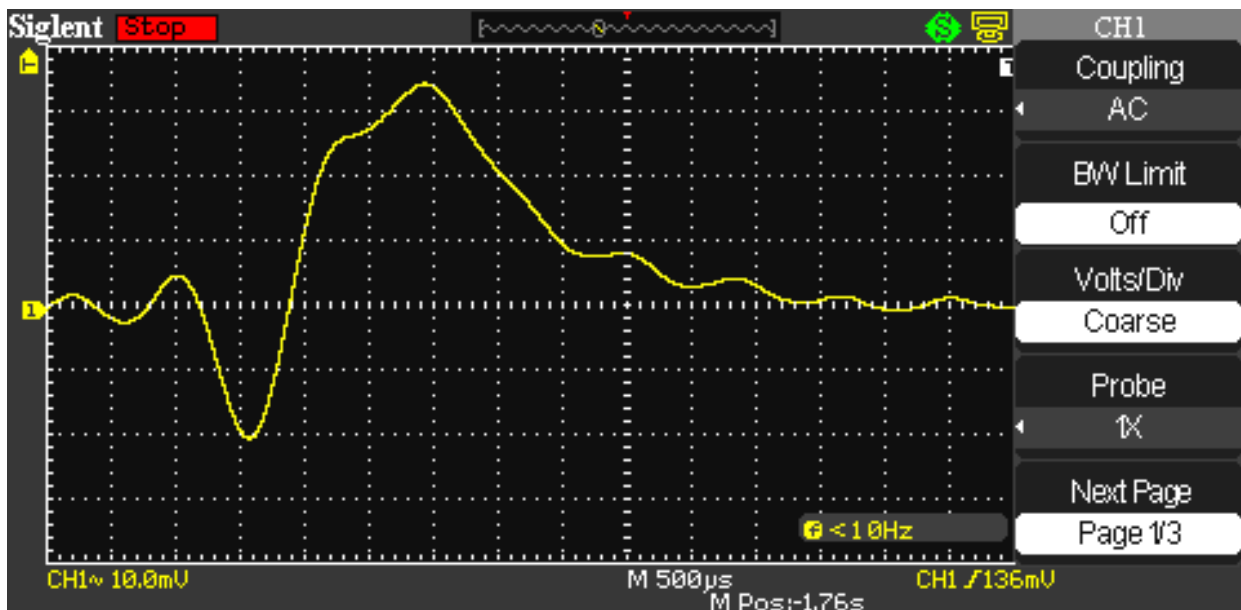

Fig. 30. Form of the voltage pulse between the external screen and the screen of Faraday cage, obtained with capacitor discharge with a capacity $6000 \mu\text{F}$, charged to the voltage 300 V . Scale along the X-axis is 5 ms .

Should be focused attention on the fact that the formation of the negative part of the pulse (Fig. 29) practically it coincides with the capacitor discharge time (Fig. 27), when through the plasma maximum current flows precisely in this time and the maximum warming-up of plasma occurs, since with the flow through it of high currents the warming-up is connected not only with its effective resistance, but also with the pinch effect.

If we compare Fig. 23, where is shown the shape of pulse with introduction into cell of Faraday of the charged amber and Fig. 29, that it is possible to see that the shapes of pulses it is very similar. The difference only in the fact that with the

mechanical introduction and the withdrawal of amber from the cell it is not possible to ensure this pulse time and the steepness of its fronts as with the electrical discharge. in Fig. 29 and Fig. 30 the stages of warming-up and cooling of plasma are well visible, evident also that its heating occurs much faster than cooling.

The results of the conducted investigations attest to the fact that in the process of formation and warming-up of plasma in it the unitary negative charge is formed. In the formed plasma the number of electrons and positive ions is equal, but electrons have high speed, than ions; therefore naturally to assume that the formation of unitary charge is

connected with the fact that the speed of electron motion more than in ions.

The total capacitance of the input circuit of oscilloscope and capacity between the screen of the Faraday cage and the external screen is 204 pF, and the resistance of the input circuit of oscilloscope equally by 1M Ω , therefore, the input circuit of oscilloscope is differentiating. Consequently, the input circuit of oscilloscope together with the capacity between the screen of the Faraday cage and the external screen, between which appears the voltage pulse, is differentiating. Therefore the oscillograms, represented in Fig. 29 and Fig. 30 they present the derivative of the voltage pulse, which appears between the screen of the cell of Faraday and the external screen.

With the explosion in space of H-bomb was discovered the pulse, shown in Fig. 17. When his record was used analog oscilloscope, but did not say what was used in this dish. Standard parameters of the input circuits is oscilloscope input capacitance of ~ 50 pF and the input resistance of ~ 1 M Ω . If we assume that a dipole antenna is used, together with the capacitance of the feeder its capacity is several hundred picofarad, and it means that the input circuit of oscilloscopes in this method of measurement are differentiating circuit. Therefore with the registration of the electric pulse of space explosion, as in our case, was recorded the derivative of the pulse, accepted by antenna. Comparison of the shape of pulse, obtained with the space explosion of the H-bomb and shape of the pulse, depicted in Fig. 29 it shows that in Fig. 17 the very short negative part of the pulse is absent. The subsequent positive parts of the pulse are very similar. This can be connected with the fact that with the explosion of H-bomb the short part of the pulse was so short, that the utilized oscilloscope had insufficient passband for the reproduction of so short a pulse.

Tests, carried out according to the diagram, depicted in Fig. 18 they showed that the shape of pulse with the identical values of the capacity of the discharged capacitor and stress on it, remains the same, as in the case of the connection of oscilloscope to the screen of Faraday cage. If we above the enamel as the second screen stick the copper foil, which repeats the outlines of the screen of Faraday cage, and to connect to the oscilloscope face, then the pulse amplitude and the shape of pulse does not change. But if we inside the external screen put the same metal intermediate screen of smaller sizes, which coincides in the form with the external screen, but with the ample clearance between it and screen of Faraday cage, then the shape of pulse remains, but its amplitude decreases. This fact means that in the process of the warming-up of plasma in it is formed the unitary electric charge, whose electric fields freely penetrate both through the screen of the cell of Faraday and through the intermediate screen, reaching external screen. These fields penetrate also through the external screen and it is possible to reveal them out of this screen with the aid of the dipole antenna, whose axis is directed to the side of external screen, but this is very difficult to make, so how there are large external interference. This experiment can be carried out only in the screened room.

Given experimental data are the proof of the fact that in the process of the warming-up of plasma with an equal quantity in it of electrons and positive ions in it is formed the unitary negative charge, not compensated by positive ions the experiment examined it directly confirms that the fact that the invariant of speed is only the polarity of the moving electric charge, but its absolute value depends on speed.

5. Concepts of Scalar-Vector Potential

The Maxwell's equations do not give the possibility to write down fields in the moving coordinate systems (RS), if fields in the fixed system are known. This problem is solved with the aid of the Lorenz conversions, however, these conversions from the classical electrodynamics they do not follow. In the unipolar generator the electric fields appear in the elements, which revolve with respect to the fixed frame of reference, but the revolving frame of reference is not inertial. For this reason for explaining the operating principle of unipolar generator it is not possible to use either the principles of classical electrodynamics, or Lorenz conversions. Question arises, can the principles of classical electrodynamics give correct results regarding field on in RS at least in some approximation, and if yes, then as the equations of electromagnetic induction must appear in this case. of indication of how can be recorded fields in the moving coordinate system, if they are known in the fixed, there are already in the Faraday law, if we use ourselves the substantial derivative [27]. For the study of this problem let us rewrite Faraday law in the precise form:

$$\oint \vec{E}' d \vec{l}' = - \frac{d \Phi_B}{d t} \quad (5.1)$$

The refinement of law, is more accurate than its record, it concerns only that circumstance that if we determine contour integral in the moving (prime) coordinate system, then near \vec{E} and $d \vec{l}$ must stand primes. But if circulation is determined in the fixed coordinate system, then primes near \vec{E} and $d \vec{l}$ be absent, but in this case to the right in expression (5.1) must stand particular time derivative. Usually this circumstance in the literature on this question is not specified.

The substantial derivative in relationship (5.1) indicates the independence of the eventual result of appearance emf in the outline from the method of changing the flow, i.e., flow can change both due to the local time derivative of the induction of and because the system, in which is measured, it moves in the three-dimensional changing field of. In relationship (5.1) the value

$$\Phi_B = \int \vec{B} d \vec{S}' \quad (5.2)$$

where the magnetic induction $\vec{B} = \mu \vec{H}$ is determined in

the fixed coordinate system, and the element of $d\vec{S}'$ is determined in the moving system. Taking into account (5.2), we obtain from (5.1)

$$\oint \vec{E}' d\vec{l}' = -\frac{d}{dt} \int \vec{B} d\vec{S}' \quad (5.3)$$

$$\oint \vec{E}' d\vec{l}' = -\int \frac{\partial \vec{B}}{\partial t} d\vec{S} - \int [\vec{B} \times \vec{V}] d\vec{l}' - \int \vec{V} \operatorname{div} \vec{B} d\vec{S}' \quad (5.4)$$

in this case contour integral is taken on the outline $d\vec{l}'$, which covers the area $d\vec{S}'$. Let us immediately note that entire following presentation will be conducted under the assumption the validity of the Galileo conversions, i.e., $d\vec{l}' = d\vec{l}$ and $d\vec{S}' = d\vec{S}$. From (5.4) follows the result

$$\vec{E}' = \vec{E} + [\vec{V} \times \vec{B}] \quad (5.5)$$

from which it follows that during the motion of charge in the magnetic field to it the additional electric field, determined by second term of the right side of the relationship acts, (5.5). Let us note that this relationship we obtained not of the Lorentz conversions, but altogether having only refined Faraday law. Thus, Lorentz force

$$\vec{F}_L = e\vec{E} + e[\vec{V} \times \vec{B}]$$

it is the direct consequence of this precise law.

From relationship (5.5) it follows that during the motion in the magnetic field to the charge acts the force perpendicular to direction of motion. However, physical nature of this force is not clear and from the times of Lorentz and Poincare it is introduced as experimental postulate. But one cannot fail to note that are not known to us such laws of the mechanics, when with the uniform rectilinear motion of body on it the force, which depends on the speed of body and normal to the direction of its motion, acts.

For explaining physical nature of the appearance of this force let us write down \vec{B} also \vec{E} in the terms the magnetic vector potential \vec{A}_B :

$$\vec{B} = \operatorname{rot} \vec{A}_B, \quad \vec{E} = -\frac{\partial \vec{A}_B}{\partial t} \quad (5.6)$$

Then relationship (5.5) can be rewritten

$$\vec{E}' = -\frac{\partial \vec{A}_B}{\partial t} + [\vec{V} \times \operatorname{rot} \vec{A}_B] \quad (5.7)$$

and further

$$\vec{E}' = -\frac{\partial \vec{A}_B}{\partial t} - (\vec{V} \nabla) \vec{A}_B + \operatorname{grad} (\vec{V} \vec{A}_B). \quad (5.8)$$

and further, since $\frac{d}{dt} = \frac{\partial}{\partial t} + \vec{V} \operatorname{grad}$, let us write down

The first two members of the right side of equality (5.8) can be gathered into the total derivative of vector potential on the time, namely:

$$\vec{E}' = -\frac{d\vec{A}_B}{dt} + \operatorname{grad} (\vec{V} \vec{A}_B) \quad (5.9)$$

From relationship (5.8) it is evident that the field strength, and consequently also the force, which acts on the charge, consists of three parts.

The first of them is obliged by the local derivative of magnetic vector potential on the time. The sense of second term of the right side of relationship (5.8) is also intelligible. It is connected with a change in the vector potential, but already because charge moves in the three-dimensional changing field of this potential. Other nature of last term of the right side of relationship (5.8). It is connected with the presence of potential forces, since. potential energy of the charge, which moves in the potential field \vec{A}_B with the speed \vec{V} , is equal $-e (\vec{V} \vec{A}_B)$. However, value $e \operatorname{grad} (\vec{V} \vec{A}_B)$ determines the force of potential nature, exactly as determines force the gradient of scalar potential.

The relationship (5.8) gives the possibility to physically explain all composing tensions electric fields, which appears in the fixed and that moving the coordinate systems. In the case of unipolar generator in the formation of the force, which acts on the charge, two last addend right sides of equality (5.8) participate, introducing identical contributions.

Thus, to speak about the unipolar generator as about "an exception to the rule of flow" is impossible [28], since flow rule, as we see, this is the totality of all three components. Taking rotor from both parts of equality (5.9) and taking into account that $\operatorname{rot} \operatorname{grad} \equiv 0$, we obtain

$$\operatorname{rot} \vec{E}' = -\frac{d\vec{B}}{dt} \quad (5.10)$$

If there is no motion, then relationship (5.10) is converted into the Maxwell first equation. Certainly, on its informativeness relationship (5.10) strongly is inferior to relationship (5.1), since. in connection with the fact that $\operatorname{rot} \operatorname{grad} \equiv 0$, in it there is no information about the potential forces, designated through $e \operatorname{grad} (\vec{V} \vec{A}_B)$. Therefore, if us interest all components of electrical field on, that act on the

charge both in the fixed and in that moving the coordinate systems, we must use relationship (5.1).

Summing up the preliminary sum, it is possible to say that with the more careful examination of the Faraday law (5.1) it is possible to sufficient clearly understand all special features of the work of unipolar generator, it is possible to also assert that the operating principle of unipolar generator is not an exception to the rule of flow (5.1), but it is its consequence. The assertion of Feynman about the fact that the rule $[\vec{V} \times \vec{B}]$

for “moving outline” and $\nabla \times \vec{E} = -\frac{\partial \vec{B}}{\partial t}$ for “changing field” they are two completely different laws it does not correspond to

$$\vec{F}' = e \vec{E} + e [\vec{V} \times \text{rot } \vec{A}_B] = e \vec{E} - e(\vec{V} \nabla) \vec{A}_B + \text{egrad } (\vec{V} \vec{A}_B) \tag{5.11}$$

is more preferable, since. the possibility to understand the complete structure of this force gives.

The Faraday law (5.1) is called the law of electromagnetic induction in connection with the fact that it shows how a change in the magnetic field on it leads to the appearance of electrical field on. However, in the classical electrodynamics there is no law of magnetoelectric induction, which would show, how a change in the electrical field on, or motion in them, it leads to the appearance of magnetic field on. The development of classical electrodynamics followed along another way. Was first known the Ampere law

$$\oint \vec{H} d \vec{l} = I \tag{5.12}$$

where I is current, which crosses the area, included by the outline of integration. In the differential form relationship (5.12) takes the form:

$$\text{rot } \vec{H} = \vec{j}_\sigma \tag{5.13}$$

where \vec{j}_σ is current density of conductivity.

$$\oint \vec{H}' d \vec{l}' = \int \frac{\partial \vec{D}}{\partial t} d \vec{S} + \oint [\vec{D} \times \vec{V}] d \vec{l}' + \int \vec{V} \text{div } \vec{D} d \vec{S}' \tag{5.16}$$

In contrast to the magnetic field on, when $\text{div } \vec{B} = 0$, for the electrical field on $\text{div } \vec{D} = \rho$ and last term in the right side of relationship (5.16) it gives the conduction current of and from relationship (5.15) the Ampere law immediately follows. From relationship (5.16) follows also the equality:

$$\vec{H} = [\vec{D} \times \vec{V}] \tag{5.17}$$

which earlier could be obtained only from the Lorentz conversions.

As shown in the work [28], from relationship (5.17) follows and Bio-Savara law, if for enumerating the magnetic field on to take the electric fields of the moving charges. In this case the last member of the right side of relationship (5.16) can be simply omitted, and the laws of induction

reality [28]. Exactly that united basic principle, absence of which indicates Feynman, and is the Faraday law.

Consequently, we must conclude that the moving or fixed charge interacts not with the magnetic field, but with the field of magnetic vector potential, and only knowledge of this potential and its evolution they give the possibility to calculate all force components, which act on the charges. However, magnetic field appears altogether only of the gradient of such vectorial field.

But one cannot fail to note that to us is not thus far clear physical nature of quite vector potential.

From the aforesaid it follows that the record of the Lorentz force in the terms of the magnetic vector potential:

Maxwell supplemented relationship (5.13) with bias current

$$\text{rot } \vec{H} = \vec{j}_\sigma + \frac{\partial \vec{D}}{\partial t} \tag{5.14}$$

However, the law of the induction was not established in the times of Ampere and Maxwell

$$\oint \vec{H}' d \vec{l}' = \frac{d \Phi_D}{d t} \tag{5.15}$$

where $\Phi_D = \int \vec{D} d S'$ is the flow of electrical induction, since then sensitivity of meters did not be sufficient for establishing this law.

Is already later in 1878 the year Rowland it experimentally proved that the convection current of free charges on the moving conductor on its magnetic action was identical with the conduction current in the quiescent conductor.

In this case relationship (3.15) can be rewritten as follows:

acquire the completely symmetrical form

$$\oint \vec{E}' d \vec{l}' = - \int \frac{\partial \vec{B}}{\partial t} d \vec{S} - \oint [\vec{B} \times \vec{V}] d \vec{l}' \tag{5.18}$$

$$\oint \vec{H}' d \vec{l}' = \int \frac{\partial \vec{D}}{\partial t} d \vec{S} + \oint [\vec{D} \times \vec{V}] d \vec{l}'$$

$$\begin{aligned} E' &= \vec{E} + [\vec{V} \times \vec{B}] \\ H' &= \vec{H} - [\vec{V} \times \vec{D}] \end{aligned} \tag{5.19}$$

Let us note that previously relationships (5.19) could be obtained only from the covariant the Lorentz conversions, i.e., within the framework the special theory of relativity (SR).

Thus, with an accuracy down to the terms $\sim \frac{V}{c}$ results SR follow from the laws of the induction within the framework of the Galileo conversions. Further we will show that they follow from conversions (5.18) and results SR with an accuracy $\sim \frac{V^2}{c^2}$. However, before this we will introduce one additional vector potential, which in the classical electrodynamics was not introduced. For the vortex field on let us accept [5]

$$\vec{D} = \text{rot } \vec{A}_D \quad (5.20)$$

where \vec{A}_D is electrical vector potential. Then from (5.19) follows

$$\vec{H}' = \frac{\partial \vec{A}_D}{\partial t} + [\vec{V} \nabla] \vec{A}_D - \text{grad } [\vec{V} \vec{A}_D] \quad (5.21)$$

or

$$\vec{H}' = \frac{\partial \vec{A}_D}{\partial t} - [\vec{V} \times \text{rot } \vec{A}_D] \quad (5.22)$$

or

$$\vec{H}' = \frac{d \vec{A}_D}{d t} - \text{grad } [\vec{V} \vec{A}_D] \quad (5.23)$$

These relationships are the writing of the law of magnetoelectric induction in the terms of electrical vector potential.

The relationship (5.19) attest to the fact that in the case of relative motion of frame of references, between the fields \vec{E} and \vec{H} there is a cross coupling, i.e., motion in the fields \vec{H} leads to the appearance field on \vec{E} and vice versa. From these relationships escape the additional consequences, which were for the first time examined in the work [5]. The

electric field $E = \frac{g}{2\pi\epsilon r}$ outside the charged length of the rod per unit length which accounts for charge g decreases like $\frac{1}{r}$, where r is the distance from the central axis of the rod to the observation point.

If we in parallel to the axis of rod in the field E begin to move with the speed of Δv another RS, then in it will appear the additional magnetic field $\Delta H = \epsilon E \Delta v$. If we now with respect to already moving RS begin to move third frame of reference with the speed Δv , then already due to the motion in the field ΔH will appear additive to the electric field $\Delta E = \mu \epsilon E (\Delta v)^2$. This process can be continued and further, as a result of which can be obtained

the number, which gives the value of the electric field $E'_v(r)$ in RS with reaching of the speed $v = n \Delta v$, when $\Delta v \rightarrow 0$, and $n \rightarrow \infty$. In the final analysis in RS the value of dynamic electric field will prove to be more than in the initial and to be determined by the relationship:

$$E'(r, v_{\perp}) = \frac{gch \frac{v_{\perp}}{c}}{2\pi\epsilon r} = Ech \frac{v_{\perp}}{c}.$$

If speech goes about the electric field of the single charge of e , then its electric field will be determined by the relationship:

$$E'(r, v_{\perp}) = \frac{ech \frac{v_{\perp}}{c}}{4\pi\epsilon r^2}, \quad (5.24)$$

where v_{\perp} is normal component of charge rate to the vector, which connects the moving charge and observation point.

Expression for the scalar potential, created by the moving charge, for this case will be written down as follows:

$$\varphi'(r, v_{\perp}) = \frac{ech \frac{v_{\perp}}{c}}{4\pi\epsilon r} = \varphi(r)ch \frac{v_{\perp}}{c}, \quad (5.25)$$

where $\varphi(r)$ is scalar potential of fixed charge. The potential $\varphi'(r, v_{\perp})$ can be named scalar-vector, since. it depends not only on the absolute value of charge, but also on speed and direction of its motion with respect to the observation point. It is not difficult to see that the obtained relationship with an accuracy to of the quadratic members of the expansion of the corresponding functions in series coincides with results SR.

Using for enumerating the conversion of magnetic field on the same method, we obtain:

$$H'(v_{\perp}) = Hch \frac{v_{\perp}}{c},$$

where v_{\perp} is speed normal to the direction of the magnetic field.

If we apply the obtained results to the electromagnetic wave and to designate components field on parallel speeds RS as E_{\parallel} , H_{\parallel} , , and E_{\perp} , H_{\perp} , as components normal to it, then with the conversion field on components, parallel to speed will not change, but components, normal to the direction of speed are converted according to the rule

$$\begin{aligned} \vec{E}'_{\perp} &= \vec{E}_{\perp} ch \frac{v}{c} + \frac{v}{c} \vec{v} \times \vec{B}_{\perp} sh \frac{v}{c}, \\ \vec{B}'_{\perp} &= \vec{B}_{\perp} ch \frac{v}{c} - \frac{1}{vc} \vec{v} \times \vec{E}_{\perp} sh \frac{v}{c}, \end{aligned} \quad (5.26)$$

where $c = \sqrt{\frac{1}{\mu_0 \epsilon_0}}$ is speed of light.

Conversions field on (5.26) they were for the first time obtained in the work [5].

However, the iteration technique, utilized for obtaining the given relationships, it is not possible to consider strict, since its convergence is not explained

A stricter conclusion, proposed by N. A. Drobyshv it is

$$\begin{aligned} \vec{E}_{1\perp} &= \vec{E}_{\perp} + \Delta\vec{v} \times \vec{B}_{\perp} & \vec{B}_{1\perp} &= \vec{B}_{\perp} - \Delta\vec{v} \times \vec{E}_{\perp} / c^2 \\ \vec{E}_{2\perp} &= \vec{E}_{1\perp} + \Delta\vec{v} \times \vec{B}_{1\perp} & \vec{B}_{2\perp} &= \vec{B}_{1\perp} - \Delta\vec{v} \times \vec{E}_{1\perp} / c^2 \end{aligned} \tag{5.27}$$

Upon transfer to each following RS of field are obtained increases in $\Delta\vec{E}$ and $\Delta\vec{B}$

$$\Delta\vec{E} = \Delta\vec{v} \times \vec{B}_{\perp}, \quad \Delta\vec{B} = -\Delta\vec{v} \times \vec{E}_{\perp} / c^2 \tag{5.28}$$

where the fields \vec{E}_{\perp} and \vec{B}_{\perp} relate to current RS. Directing the Cartesian axis of x along $\Delta\vec{v}$, let us rewrite (5.28) in the components of the vector

$$\Delta E_y = -B_z \Delta v, \quad \Delta E = B_y \Delta v, \quad \Delta B_y = E_z \Delta v / c^2 \tag{5.29}$$

Relationship (5.29) can be represented in the matrix form

$$\Delta U = AU\Delta v \quad U = \begin{pmatrix} E_y \\ E_z \\ B_y \\ B_z \end{pmatrix}$$

$$\begin{pmatrix} 0 & 0 & 0 & -1 \\ 0 & 0 & 1 & 0 \\ 0 & 1/c^2 & 0 & 1 \\ -1/c^2 & 0 & 0 & 0 \end{pmatrix}$$

If one assumes that the speed of system is summarized for the classical law of addition of velocities, i.e., the speed of final RS $K' = K_N$ relative to the initial K is $v = N\Delta v$, then we will obtain the matrix system of the differential equations

$$\frac{dU(v)}{dv} = AU(v) \tag{5.30}$$

with the matrix of the system of v independent of the speed A . The solution of system is expressed as the matrix exponential curve $\exp(vA)$:

$$U' \equiv U(v) = \exp(vA)U, \quad U = U(0) \tag{5.31}$$

$$A^2 = \begin{pmatrix} -\alpha^2/c^2 & 0 \\ 0 & -\alpha/c^2 \end{pmatrix}, \quad A^3 = \begin{pmatrix} 0 & \alpha^3/c^2 \\ -\alpha^3/c^4 & 0 \end{pmatrix}, \quad A^4 = \begin{pmatrix} \alpha^4/c^4 & 0 \\ 0 & \alpha^4/c^4 \end{pmatrix}, \quad A^5 = \begin{pmatrix} 0 & -\alpha^5/c^4 \\ \alpha^5/c^6 & 0 \end{pmatrix} \dots$$

And the elements of matrix exponential curve take the form

$$[\exp(vA)]_{11} = [\exp(vA)]_{22} = I - \frac{v^2}{2!c^2} + \frac{v^4}{4!c^4} - \dots,$$

possible to obtain by in the matrix form [15].

Let us examine the totality RS of such, that Rs K_1 moves with the speed Δv relative to ISO K , ISO K_2 moves with the same speed Δv relative to K_1 , etc. If the module of the speed Δv is small (in comparison with the speed of light c), then for the transverse components field on in RS $K_1 K_2 \dots$ we have:

here U is matrix column field on in the system K , and U' is matrix column field on in the system K' . Substituting (5.31) in the system (5.30), we are convinced, what U' is actually the solution of the system (5.30):

$$\frac{dU(v)}{dv} = \frac{d[\exp(vA)]}{dv}U = A\exp(vA)U = AU(v)$$

It remains to find this exponential curve by its expansion in the series:

$$\exp(va) = E + vA + \frac{1}{2!}v^2A^2 + \frac{1}{3!}v^3A^3 + \frac{1}{4!}v^4A^4 + \dots$$

where E is unit matrix with the size of 4×4 . For this it is convenient to write down the matrix A in the unit type form of

$$A = \begin{pmatrix} 0 & -\alpha \\ \alpha/c^2 & 0 \end{pmatrix}, \quad \alpha = \begin{pmatrix} 0 & 1 \\ -1 & 0 \end{pmatrix}, \quad 0 = \begin{pmatrix} 0 & 0 \\ 0 & 0 \end{pmatrix}.$$

then

$$[\exp(vA)]_{21} = -c^2 [\exp(vA)]_{12} = \frac{\alpha}{c} \left(\frac{v}{c} I - \frac{v^3}{3!c^3} + \frac{v^5}{5!c^5} - \dots \right),$$

Where I is the unit matrix 2×2 . It is not difficult to see that $-\alpha^2 = \alpha^4 = -\alpha^6 = \alpha^8 = \dots = I$, therefore we finally obtain

$$\exp(vA) = \begin{pmatrix} Ichv/c & -\alpha shv/c \\ (\alpha shv/c)/c & Ichv/c \end{pmatrix} = \begin{pmatrix} chv/c & 0 & 0 & -cshv/c \\ 0 & chv/c & cshv/c & 0 \\ 0 & (chv/c)/c & chv/c & 0 \\ -(shv/c)/c & 0 & 0 & chv/c \end{pmatrix}$$

Now we return to (5.31) and substituting there $\exp(vA)$, we find

$$\begin{aligned} E'_y &= E_y ch v/c - cB_z sh v/c, & E'_z &= E_z ch v/c + cB_y sh v/c, \\ B'_y &= B_y ch v/c + (E_z/c) sh v/c, & B'_z &= B_z ch v/c - (E_y/c) sh v/c \end{aligned}$$

Or in the vector record

$$\begin{aligned} \vec{E}'_{\perp} &= \vec{E}_{\perp} ch \frac{v}{c} + \frac{v}{c} \vec{v} \times \vec{B}_{\perp} sh \frac{v}{c}, \\ \vec{B}'_{\perp} &= \vec{B}_{\perp} ch \frac{v}{c} - \frac{1}{vc} \vec{v} \times \vec{E}_{\perp} sh \frac{v}{c}. \end{aligned} \quad (5.32)$$

This is conversions (5.26).

The carried out experiments showed that in the process of the warming-up of plasma inside Faraday cage appears the unitary charge, whose fields penetrate through the metal screen of Faraday cage. This confirms the fact that even when entrance of oscilloscope it does not have galvanic contact with the screen of Faraday cage, but it is connected to the intermediate screen, with the warming-up of plasma is fixed the pulse of the same form as with the connection of the entrance of oscilloscope to the screen of cell.

6. An explanation of the Experimental Results within the concept of a Scalar-Vector Potential

The carried out experiments showed that in the process of the warming-up of plasma inside Faraday cage appears the unitary charge, whose fields penetrate through the metal screen of Faraday cage. This behavior of plasma does not

find its explanation of the within the framework existing theories. The thus far only theory, which can explain this phenomenon, is the concept of scalar-vector potential, examined in the previous division. The conducted investigations do not make it possible to make numerical calculations according to this theory, since to us are not known the parameters of the plasma, the generatrix as a result of capacitor discharge through the discharger. However, we have the experimental data, obtained according to the program «Starfish». In Fig. 31 is given the map of the tension of electrical pour on pulse, obtained with the tests according to this program.

It is evident from the given map that in the epicentre of explosion the tension of electrical pour on it reaches value 52100 V/m.

If we consider that one ton of trotyl is equivalent 4.6×10^9 J, then with the explosion of bomb with the TNT equivalent 1,4 Mt. are separated $\sim 6.44 \times 10^{15}$ J. Consequently explosive force in the time interval indicated will compose $\sim 3.7 \times 10^{22}$ W. For the comparison let us point out that the power of the radiation of the Sun $\sim 3.9 \times 10^{26}$ W.

Let us examine a question, where how, in so short a time, can be the intake, isolated with this explosion. With the explosion in the atmosphere the energy is expended on the emission and on the creation of shock wave. In space shock wave is absent; therefore explosive energy is expended on the electromagnetic radiation.

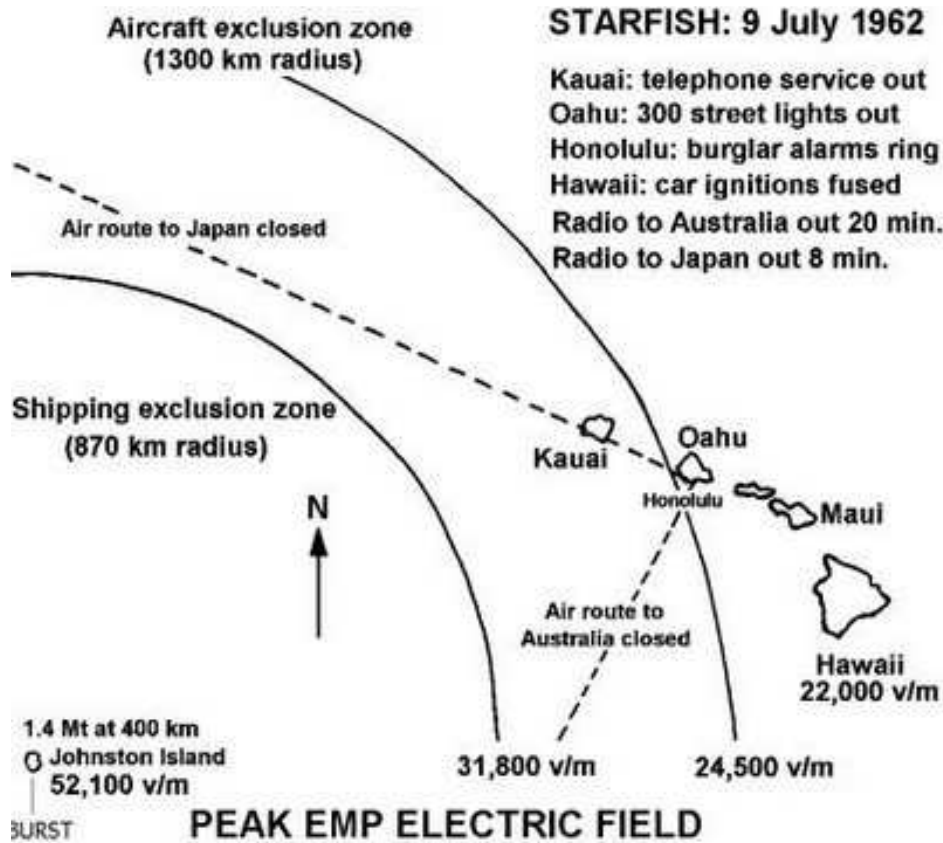

Fig. 31. Map of tests according to the program «Starfish».

In accordance with Stephan equation Boltzmann the power, radiated by the heated surface, is proportional to the fourth degree of its temperature:

$$P = \sigma ST^4,$$

where σ is Stefan-Boltzmann constant, and S is area of radiating surface.

In order to calculate temperature with the known radiated power it is necessary to know the surface of radiating surface. As this surface let us select sphere with the surface $\sim 3 \text{ m}^2$. Approximately this area characterizes the cloud of explosion at the moment of the detonation of thermonuclear charge. Knowing explosive force and size of radiating surface, we find the temperature of the cloud of the explosion

$$T = \sqrt[4]{\frac{P}{\sigma S}}.$$

With the explosive force $\sim 3.7 \times 10^{22} \text{ W}$ we obtain the value of temperature $\sim 8.6 \times 10^6 \text{ K}$. The obtained value coincides well with the values of the initial temperature of the cloud of explosion with the thermonuclear explosions.

In the concept of scalar- vector potential, the scalar potential of charge it is determined from the relationship

$$\varphi(r) = \frac{g \text{ ch } \frac{v_{\perp}}{c}}{4\pi \epsilon_0 r}, \tag{6.1}$$

where r is the distance between the charge and the observation point, v_{\perp} is the component of the charge rate of g , normal to the vector \vec{r} , ϵ_0 is dielectric constant of vacuum.

According to the estimations at the initial moment of thermonuclear explosion the temperature of plasmoid can reach several hundred million degrees. At such temperatures the electron gas is no longer degenerate and is subordinated to the distribution of Boltzmann. The most probable electron velocity in this case is determined by the relationship

$$v = \sqrt{\frac{2k_b T}{m}}, \tag{6.2}$$

where T is temperature of plasma, k_b is the Boltzmann constant, m is the mass of electron.

Using relationships (6.1) and (6.2), and taking into account with the expansion in the series of hyperbolic cosine the terms $\sim \frac{v^2}{c^2}$, we obtain the value of increase in the scalar potential at the observation point

$$\Delta\varphi \cong \frac{Nek_b T}{4\pi\epsilon_0 rmc^2}, \tag{6.3}$$

where N is quantity of electrons in the cloud of explosion, e is electron charge. We determine from the formula the

tension of radial electric field, which corresponds to this increase in the potential:

$$E = \frac{Nek_b T}{4\pi\epsilon_0 r^2 mc^2} = \frac{\Delta q}{4\pi\epsilon_0 r^2}, \tag{6.4}$$

where

$$\Delta q = \frac{Nek_b T}{mc^2} \tag{6.5}$$

is an equivalent charge of explosion.

One should say that with the warming-up of plasma the ions also acquire additional speed, however, since their mass considerably more than the mass of electrons, increase in their charges can be disregarded.

For enumerating the quantity of electrons it is necessary to know a quantity of atoms, which with the warming-up formed the cloud of explosion. Let us assume that the total weight of bomb and launch vehicle, made from metal with

the average density of the atoms $\sim 5 \times 10^{22}$ 1/sm³ is 1000 kg. General of a quantity of free electrons in the formed plasma, on the assumption that all atoms will be singly ionized with the specific weight of the metal ~ 8 g/cm³ will comprise $\sim 5 \times 10^{27}$.

In accordance with formula (6.4) the tension of radial electric field at a temperature of the cloud of the explosion $\sim 8.6 \times 10^6$ K will comprise in the epicentre of the explosion $\sim 6.9 \times 10^4$ V/m. It is evident that in the epicentre the computed values of electrical pour on on the earth's surface they are close to the experimental values. Varying the weight of bomb and launch vehicle easy to obtain values pour on, the being approached experimental values.

It remains to explain, with which is connected strong ionospheric disturbance at large distances from the points of impact, which were being observed with the tests.

Let us first examine the case, when charge is located above the metallic conducting plane (Fig. 32). The distribution of electrical field on above this plane well known [28].

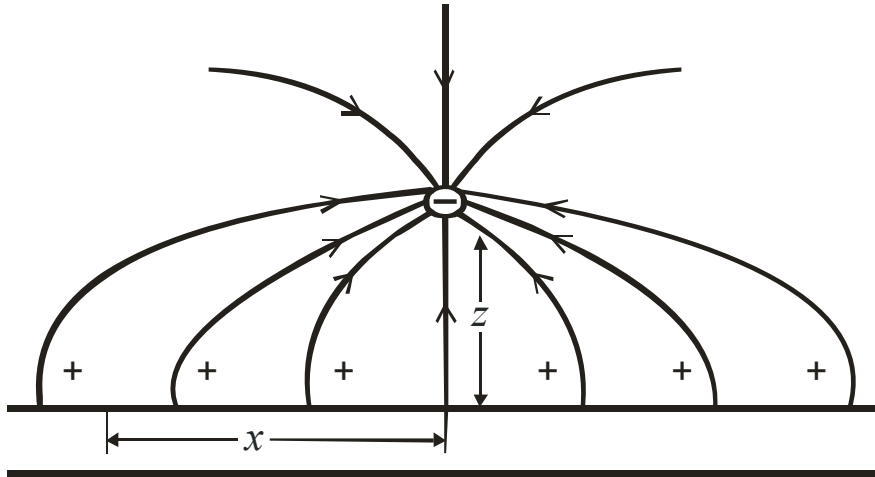

Fig. 32. Negative charge above the limitless conducting plane.

The horizontal component of electric field on the surface of this plane is equal to zero, and normal component is equal:

$$E_{\perp} = \frac{1}{2\pi\epsilon_0} \frac{zq}{(z^2 + x^2)^{\frac{3}{2}}}, \tag{6.6}$$

where q is magnitude of the charge, z is distance from the charge to its epicentre, x is distance against the observation points to the epicentre.

Lower than conducting plane electric fields be absent, but this configuration pour on equivalent to the presence under the conducting plane of the positive charge of the same value and at the same distance as initial charge. They indicate that in the conducting plane the charge sees its mirror reflection. The pair of such charges presents the electric dipole with the appropriate distribution of electrical pour on. This configuration pour on connected with the fact that charge, which is been located above the conducting plane, it induces

in it such surface density of charges, which completely compensates horizontal and vertical component of the electric field of charge in the conducting plane and lower than it. The dependence of the area of the charge density from the coordinate of x also is well known [28]

$$\sigma(x) = \epsilon_0 E_{\perp} = \frac{1}{2\pi} \frac{zq}{(z^2 + x^2)^{\frac{3}{2}}}. \tag{6.7}$$

If we integrate $\sigma(x)$ with respect to the coordinate x , then we will obtain magnitude of the charge, which is been located above the conducting plane. In such a way as not to pass the electric fields of the charge of q through the conducting plane, in it must be contained a quantity of free charges, which give summary charge not less than the charge q . In this case two cases can realize. With the low charge density, which occurs in the poor conductors, it will arrive to move up to the significant distances significant quantities of

charges. But in this case of charges it can and not be sufficient for the complete compensation. With the high charge density, it is possible to only insignificantly move charges in the plane. This case realizes in the metallic conductors.

If we periodically draw near and to move away charge from the plane, then in it will arise the periodic horizontal currents, which will create the compensating surface charges. The same effect will be observed, if charge at the particular point can be born and disappear. If at the assigned point above the plane charge suddenly in some time arises, then, so that the fields of charge would not penetrate through the conducting plane, in the same time on the conducting plane the compensating charges, which correspond to relationship must appear (6.7). This means that the strength of currents, which create the compensating charges, there will be the greater, the greater charge itself and the less the time of its appearance. However, with the low charge density can realize another case. With a very rapid change in the electric field the charges will not have time to occupy the places, which correspond to the complete compensation for electrical pour on, and then the fields of external charge partially will penetrate through conductor, and compensation will be not complete. Specifically, this case realizes in the case of the explosion of nuclear charge in space, since between it and earth's surface is located the ionosphere, which possesses not too high a conductivity (Fig. 33).

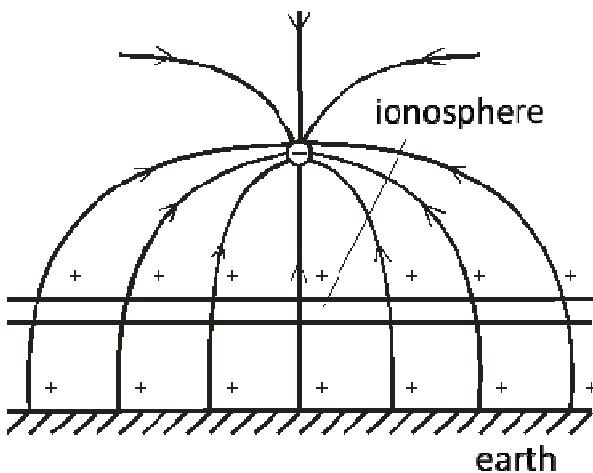

Fig. 33. Negative charge above the earth's surface with the presence of the ionosphere.

If charge will appear at the indicated in the figure point, thus it will gather under itself the existing in the ionosphere free charges of opposite sign for compensating those pour on, which it creates in it. However, if a total quantity of free positive charges in the ionosphere will be less than the value of charge itself, or their displacement is insufficient in order to fall into the necessary point at the assigned moment, then their quantity will not be sufficient for the complete compensation pour on the appearing charge and its fields will penetrate through the ionosphere. In this case the penetrated fields, in view of the screening effect of the ionosphere, can

be less than the field above it. In this case maximum compensation pour on it will occur in the region, situated directly under the charge. This process will make the dependence of electrical pour on from the distance by smoother, that also is observed during the experiment. Entire this picture can be described only qualitatively, because are accurately known neither thickness of the ionosphere nor degree of its ionization on the height. But even if are known these parameters, then bulky numerical calculations are necessary for the solution of problem.

The sphericity of the ionosphere also superimposes its special features on the process of the appearance of the compensating surface charges. This process is depicted in Fig. 34

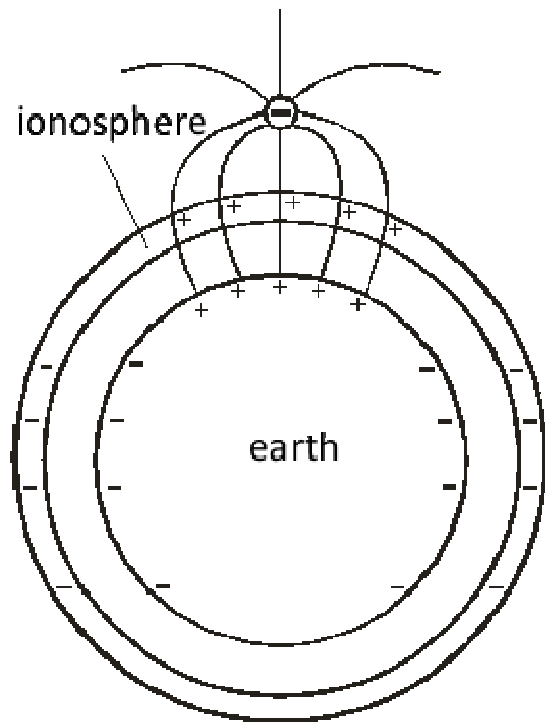

Fig. 34. Negative charge above the earth's surface with the presence of the ionosphere.

The tendency of the emergent charge to gather under itself the compensating charges will lead to the longitudinal polarization of the substantial part of the ionosphere. The compensating positive charges in the ionosphere will in essence appear directly in the epicentre, where they will be in the surplus, while beyond the line-of-sight ranges in the surplus will be negative charges. And entire system charge - the ionosphere - the earth will obtain additional dipole moment.

The model examined speaks, that nuclear explosion will lead not only to the appearance the electromagnetic pulse in the zone of straight visibility, but also to the global ionospheric disturbance. Certainly, electric fields in space in the environments of the explosion, where there is no screening effect of the ionosphere, have high values and present large danger to the automatic spacecraft.

Now should be made one observation apropos of term itself the electromagnetic pulse (EMP), utilized in the literary sources. From this name should be excluded the word magnetic, since this process presents the propagation only of radial electrical pour on, and in this case magnetic fields be absent.

It is not difficult to calculate that energy, which with the nuclear explosion is expended on obtaining of electric pulse. The pulse duration is ~ 150 ns. If we consider that the pulse is extended with the speed of light, then its extent in the free space composes $d = 45$ m. At a distance $R = 400$ km from the point of impact the tension of electric field was ~ 50000 V/m. Specific electric field energy composes

$$W = \frac{1}{2} \varepsilon_0 E^2.$$

The total energy U of the electric field of pulse we obtain by the way of the multiplication of specific energy by the volume of the spherical layer of $4\pi r^2 d$

$$U = 2\pi r^2 d \varepsilon_0 E^2.$$

Substituting in this formula the values indicated, we obtain energy $\sim 10^{12}$ J. If we consider that with the explosion is separated energy $\sim 6.4 \times 10^{15}$ J, then energy of electric pulse composes $\sim 0.016\%$ of the general explosive energy.

It is another matter that electric fields can direct currents in the conducting environments, and these currents will generate magnetic fields, but this already second phenomenon.

Since the tension of electrical field on near the nuclear explosion it is great it can reach the values of the breakdown tension of air (300000 V/m), with the explosions, achieved in immediate proximity from the earth's surface, this can lead to the formation of lightning, that also is observed in practice.

If the principle of the formation of electric pulse examined is accurate, then the usual explosions, with which is formed cold plasma, they must be accompanied by the appearance of electric pulse, although less intensive than with the nuclear explosion.

The disintegration of the molecule of trotyl with its detonation occurs according to the following diagram:

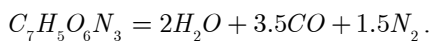

If each of the molecules, that was released during explosion will be singly ionized, then upon decay the molecule of trotyl will be isolated 7 free electrons. Consequently, with the detonation of one mole of trotyl will be isolated $7N_A = 4.2 \times 10^{24}$ of the electrons, where N_A is Avagadro's number. With the explosion of trotyl the temperature of the cloud of explosion reaches 3500 K. If all molecules of disintegration obtain single ionization, then the maximum strength of field of electric pulse composed

$$E = 3.7 \times 10^9 \frac{1}{r^2} \text{ V/m}$$

At a distance of 100 m of the point of impact the tension of electric field there will be the wound of 3.7×10^5 V/m. However, with the explosion of trotyl charges is formed the cold plasma, in which the degree of ionization composes $\sim 0.1\%$. The summary tension of electric field in this case will comprise The importance of this method consists in the fact that by studying the topology of pulse, it is possible to judge the knocking processes and subsequent relaxation of the cloud of explosion. Obviously, electric pulse must accompany the entry of projectile into different solid obstacles, since. in this case strong local warming-up to target with the formation of plasma occurs. Consequently, it is possible to draw the conclusion that in those places, where the plasma of any form is formed, must appear electric pulse.

In the scientific literature there are no communications about the appearance of electric pulse with the explosions of conventional explosives, but this can be connected with the fact that this question no one was investigated.

7. Conclusion

In the article it is experimentally proven that the introduction and the withdrawal of the charged model of amber from Faraday cage leads to the formation of the voltage pulse between the Faraday cage and the external screen, which surrounds cell. The shape of this pulse is defined by both the properties of the charged amber and by properties of the input circuits of the oscilloscope, with the aid of which is produced the record of pulse. The obtained results attest to the fact that the electric fields of the unitary charge, introduced into Faraday cage, without difficulty penetrate through the metal screen of cell.

Also experimentally proved that the unitary charge occurs in the Faraday cage and in the case where the cell is in mechanical deformation or destruction of samples made of metal or dielectric. The same phenomenon is observed on heating the plasma in the Faraday cage.

Usual and nuclear charges contain not only explosive, but also durable shells. In the usual charges with the break these shells form not only splinters, but also electric pulse, characteristic of the appearance of unitary charge. In the cannon version of A-bomb also is used the durable shell, which with the explosion must give electric pulse. For example, in the A-bombs, discarded in Hiroshima and Nagasaki as such shells served sections it was trunk the usual instruments 162 of caliber.

The detonation both of usual and nuclear charges precedes the strong compression of explosive, which also must lead to the appearance of the electric pulse of the specific polarity. All these factors in the totality form the electric pulse of explosion. It is thus far difficult to say, which of these factors is determining, and for explaining this additional experimental studies are necessary. But one should assume that with the explosion of the usual charges, when the

temperature of the generatrix of plasma is not too high, the basic contribution to the formation of electric pulse must introduce the break of the shell of projectile. In the case of nuclear explosions, the basic contribution to the formation of electric pulse must introduce the warming-up of plasma, since its temperature can reach hundreds of millions of degrees.

The proposed article gives only the part of the answers to the presented questions, whereas the remaining part of the questions requires the additional experimental studies, including and polygon nature, which cannot be under laboratory conditions conducted.

It should be noted that proposed procedure is the effective means of such of experiments, since it is remote.

Acknowledgement

I express deep gratitude to Professor Anatoly Dubrovin for a discussion of the results and the text of which contributed to a significant improvement in her. I also thank Igor Shurupov for help in preparing the experimental setup.

References

- [1] F. F. Mende, The Electro spectroscopy. Engineering Physics, №9, 2012, p. 16-18.
- [2] F. F. Mende, The problem of contemporary physics and method of their solution, LAP LAMBERT Academic Publishing, 2013.
- [3] F. F. Mende. Electro Spectroscopy of Materials and Samples, *Journal of Materials Sciences and Applications Vol.1 , No. 2, 2015, pp. 70-77*
- [4] L. U. Ricketts, J. E. Bridges, J. Mayletta. Electromagnetic pulse and methods of protection. Trans. from English. - Atomizdat 1979.
- [5] V. M. Lobarev, B. V. Zamyshlaev, E. P. Maslin, B. A. Shilobreyev. The physics of a nuclear explosion: Action explosion. - M.: Nauka. FIZMATLIT., 1997. - T. 2.
- [6] Known and unknown Zeldovich (In memories of friends, colleagues, students), Nauka, Moscow, 1993. (Edited by S. S. Gerstein and R. A. Sunyaev).
- [7] F. F. Mende. Electric pulse thermonuclear explosion Space, Engineering Physics, №5, 2013, p. 16-24.
- [8] F. F. Mende, On refinement of equations of electromagnetic induction, – Kharkov, deposited in VINITI, No 774 – B88 Dep., 1988.
- [9] F. F. Mende. Are there errors in modern physics. Kharkov, Constant, 2003.
- [10] F. F. Mende. Consistent electrodynamics, Kharkov NTMT, 2008.
- [11] F. F. Mende. On refinement of certain laws of classical electrodynamics, arXiv, physics/0402084.
- [12] F. F. Mende Conception of the scalar-vector potential in contemporary electrodynamics, arXiv.org/abs/physics/0506083.
- [13] F. F. Mende, Concept of Scalar-Vector Potential in the Contemporary Electrodynamics, Problem of Homopolar Induction and Its Solution, *International Journal of Physics, 2014, Vol. 2, No. 6, 202-210*
- [14] F. F. Mende, Problems of Lorentz Force and Its Solution, *International Journal of Physics, 2014, Vol. 2, No. 6, 211-216.*
- [15] F. F. Mende, Consideration and the Refinement of Some Laws and Concepts of Classical Electrodynamics and New Ideas in Modern Electrodynamics, *International Journal of Physics, 2014, Vol. 2, No. 8, 231-263.*
- [16] F. F. Mende. Concept of the dispersion of electric and magnetic inductivities and its physical interpretation. Global Journal of Researches in Engineering: A Mechanical and Mechanics Engineering, 2014, Vol. 14, No. 8, 11-18.
- [17] F. F. Mende. Physics of Magnetic Field and Vector Potential. *AASCIT Journal of Physics. Vol. 1, No. 1, 2015, pp. 19-27.*
- [18] F. F. Mende. The Classical Conversions of Electromagnetic Fields on Their Consequences. *AASCIT Journal of Physics. Vol. 1, No. 1, 2015, pp. 11-18.*
- [19] F. F. Mende. Electrical Impulse of Nuclear and Other Explosions. *Engineering and Technology. Vol. 2, No. 2, 2015, pp. 48-58.*
- [20] F. F. Mende. Concept of Scalar-Vector Potential and Its Experimental Confirmation, *AASCIT Journal of Physics, Vol.1, No.3, Page: 135-148*
- [21] F. F. Mende What is Common and What Difference Between the Equations of Maxwell and the Kirgof Laws, *AASCIT Journal of Physics, Publication Date: May 8, 2015, Pages: 111-123.*
- [22] F. F. Mende Updated Electrodynamics, *AASCIT Journal of Physics, Publication Date: Jun. 2, 2015, Pages: 149-170, 19 Views Since Jun. 2, 2015 , 13 Downloads Since Jun. 2, 2015.*
- [23] W.F. Edwards, C.S. Kenyon, D.K. Lemon, Continuing investigation into possible electric arising from steady conduction current, *Phys. Rev. D 14, 922 (1976).*
- [24] Roser W.G.V. Second-Order Electric Field due to a Conducting Current. *American Journal of Physics, 1962, v. 30, №7, p. 509-511.*
- [25] Don A. Baker. Second-Order Electric Field due to a Conducting Current. *American Journal of Physics, 1964, v.32, № 2, p. 153-157.*
- [26] F. F. Mende. Experimental corroboration and theoretical interpretation of dependence of charge value on DC flow velocity through superconductors. Proceedings International Conference “Physics in Ukraine”, Kiev, 1993.
- [27] J. Jackson. *Classical Electrodynamics*, Mir, Moscow, 1965.
- [28] R. Feynman, R. Leighton, M. Sands. *Feynman lectures on physics*, – M..Mir, Vol. 6, 1977.